



**Owner's Manual for the Vehicle.**  
**With a quick reference guide**  
**for your convenience.**



**325i**  
**325xi**

Congratulations, and thank you for choosing a BMW.

Thorough familiarity with your vehicle will provide you with enhanced control and security when you drive it. We therefore have this request:

Please take the time to read this Owner's Manual and familiarize yourself with the information that we have compiled for you before starting off in your new vehicle. It contains important data and instructions intended to assist you in gaining maximum use and satisfaction from the unique range of technical features on your BMW. The manual also contains information on care and maintenance designed to enhance operating safety and contribute to maintaining the value of your BMW throughout an extended service life.

This Owner's Manual should be considered a permanent part of this vehicle. It should stay with the vehicle when sold to provide the next owner with important operating, safety and maintenance information.

This manual is supplemented by a Service and Warranty Information Booklet (US models) or a Warranty and Service Guide Booklet (Canadian models). We recommend that you read this publication thoroughly.

Your BMW is covered by the following warranties:

- New Vehicle Limited Warranty
- Limited Warranty Rust Perforation
- Federal Emissions System Defect Warranty
- Federal Emissions Performance Warranty
- California Emission Control System Limited Warranty

Detailed information about these warranties is listed in the Service and Warranty Information Booklet (US models) or in the Warranty and Service Guide (Canadian models).

We wish you an enjoyable driving experience.

BMW AG

## Notes on the Owner's Manual

We have made every effort to ensure that you are able to find what you need in this Owner's Manual as quickly as possible. The fastest way to find certain topics is by using the detailed index at the end. If you wish to gain only an initial overview of your vehicle, you will find this in the first chapter.

The detailed list of contents that directly follows the summary of contents is intended to stimulate your curiosity regarding your BMW and to encourage you to read the manual.

Should you wish to sell your BMW at some time in the future, please remember to hand over the Owner's Manual to the new owner; it is part of the vehicle.

If you have any questions, an authorized BMW center will be glad to advise you.

© 2000 BMW AG  
Munich, Germany  
Reprinting, including excerpts, only with the written consent of BMW AG, Munich.  
Order no. 01 41 0 155 307  
US-English IX/00  
Printed in Germany  
Printed on environmentally friendly paper  
(bleached without chlorine, suitable for recycling).

## Symbols used



Indicates instructions or precautions that must be followed precisely in order to avoid the possibility of personal injury and serious damage to the vehicle. ◀



Contains information that will assist you in gaining the optimum benefit from your vehicle and enables you to care more effectively for your vehicle. ◀



Refers to measures that can be taken to help protect the environment. ◀

◀ Marks the end of a specific item of information.

\* Indicates special equipment, country-specific equipment and optional extras.



Identifies systems or components, which your BMW center can either activate or adapt to suit an individual driver's requirements ("Car Memory", "Key Memory"). Refer to page 52. ◀

## The individual vehicle

On buying your BMW, you have decided in favor of a model with individualized equipment and features. This Owner's Manual describes all models and equipment that BMW offers within the same group.

We hope you will understand that equipment and features are included that you might not have chosen for your vehicle. Any differences can easily be identified, since all optional accessories and special equipment are marked with an asterisk \*.

If your BMW features equipment which is not described in this Owner's Manual (car radio or telephone, for instance), Supplementary Owner's Manuals are enclosed. We ask you to read these manuals as well.

### **Status at time of printing**

BMW pursues a policy of continuous, ongoing development that is conceived to ensure that our vehicles continue to embody the highest quality and safety standards combined with advanced, state-of-the-art technology. For this reason, it is possible that the features described in this Owner's Manual could differ from those on your vehicle. Nor can errors and omissions be entirely ruled out. You are therefore asked to appreciate that no legal claims can be entertained on the basis of the data, illustrations or descriptions in this manual.

## For your own safety



Use unleaded gasoline only. Fuels containing up to and including 10% ethanol or other oxygenates with up to 2.8% oxygen by weight (that is, 15% MTBE or 3% methanol plus an equivalent amount of co-solvent) will not void the applicable warranties respecting defects in materials or workmanship. Field experience has indicated significant differences in fuel quality (volatility, composition, additives, etc.) among gasolines offered for sale in the United States and Canada. The use of poor quality fuels may result in driveability, starting and stalling problems especially under certain environmental conditions, such as high ambient temperature and high altitude. Should you encounter driveability problems which you suspect could be related to the fuel you are using, we recommend that you respond by switching to a recognized high-quality brand. Failure to comply with these recommendations may result in unscheduled maintenance. Follow the relevant safety rules when you are handling gasoline. ◀



## Important safety information!

For your own safety, use genuine parts and accessories approved by BMW.

When you purchase accessories tested and approved by BMW and Original BMW Parts, you simultaneously acquire the assurance that they have been thoroughly tested by BMW to ensure optimum performance when installed on your vehicle.

BMW warrants these parts to be free from defects in material and workmanship.

BMW will not accept any liability for damage resulting from installation of parts and accessories not approved by BMW.

BMW cannot test every product made by other manufacturers to verify if it can be used on a BMW safely and without risk to either the vehicle, its operation, or its occupants.

Original BMW Parts, BMW Accessories and other products approved by BMW, together with professional advice on using these items, are available from all BMW centers.

Installation and operation of non-BMW approved accessories such as alarms, radios, amplifiers, radar detectors, wheels, suspension components, brake dust shields, telephones (including operation of any portable cellular phone from within the vehicle without using an externally mounted antenna) or transceiver equipment (such as C.B., walkie-talkie, ham radio or similar) may cause extensive damage to the vehicle, compromise its safety, interfere with the vehicle's electrical system or affect the validity of the BMW Limited Warranty. See your BMW center for additional information.

Do not use key or remote to lock doors or trunk with anyone inside the car. See Owner's Manual for more details. ◀



Maintenance, replacement, or repair of the emission control devices and systems may be performed by any automotive repair establishment or individual using any certified automotive part. ◀

## Symbol on vehicle parts



Indicates that you should consult the relevant section of this Owner's Manual for information on a particular part or assembly.

The following applies only to vehicles owned and operated in the US.

## **REPORTING SAFETY DEFECTS**

If you believe that your vehicle has a defect that could cause a crash or could cause injury or death, you should immediately inform the National Highway Traffic Safety Administration (NHTSA) in addition to notifying BMW of North America, Inc., P.O. Box 1227, Westwood, New Jersey 07675-1227, Telephone (201) 307-4000.

If NHTSA receives similar complaints, it may open an investigation, and if it finds that a safety defect exists in a group of vehicles, it may order a recall and remedy campaign. However, NHTSA cannot become involved in individual problems between you, your dealer, or BMW of North America, Inc.

To contact NHTSA, you may either call the Auto Safety Hotline toll-free at 1-800-424-9393 (or 366-0123 in Washington, D.C. area) or write to: NHTSA, U.S. Department of Transportation, Washington, D.C. 20590. You can also obtain other information about motor vehicle safety from the Hotline.





Overview

Controls and features

Operation, care  
and maintenance

Owner service procedures

Advanced technology

Technical data

Index



# Contents

## Overview

- Cockpit 16
- Instrument cluster 18
- Indicator and warning lamps 20
- Multifunction steering wheel (MFL) 24
- Sports steering wheel 25
- Hazard warning flashers 26
- Warning triangle 26
- First-aid kit 26
- Refueling 27
- Fuel specifications 28
- Tire inflation pressure 28

## Controls and features

- Opening and closing:**
  - Keys 32
  - Electronic vehicle immobilizer 33
  - Central locking system 34
  - Opening and closing – from the outside 34
  - Opening and closing – from the inside 38
  - Tailgate 38
  - Cargo area 40
  - Alarm system 41
  - Electric power windows 43
  - Sliding/tilt sunroof 44
- Adjustments:**
  - Seats 46
  - Seat and mirror memory 49
  - Steering wheel 50
  - Mirrors 51
  - Car Memory, Key Memory 52
- Passenger safety systems:**
  - Safety belts 53
  - Airbags 55
  - Transporting children safely 58

## Driving:

- Steering/Ignition lock 61
- Starting the engine 61
- Switching off the engine 62
- Parking brake 63
- Manual transmission 64
- Automatic transmission with Steptronic 65
- Turn signal indicator/Headlamp flasher 68
- Washer/Wiper system 68
- Rear window defroster 70
- Cruise control 71

## Everything under control:

- Odometer 73
- Tachometer 73
- Energy Control 73
- Fuel gauge 74
- Coolant temperature gauge 74
- Service Interval Display 74
- Check Control 75
- Clock 75
- Computer 76

## Technology for safety and driving convenience:

- Park Distance Control (PDC) 78
- Automatic Stability Control plus Traction (ASC+T) 79
- Dynamic Stability Control (DSC) 80
- Tire Pressure Control (RDC) 85

**Controls and features****Lamps:**

- Side lamps/Low beams 87
- Instrument lighting 87
- High beams/Parking lamps 88
- Fog lamps 88
- Interior lamps 88

**Controlling the climate for pleasant driving:**

- Air conditioner 90
- Automatic climate control 96
- Seat heating 100

**Cabin convenience:**

- HiFi system 101
- Glove compartment 101
- Storage compartments 102
- Cellular phone 103
- Ashtray, front 104
- Cigarette lighter 104
- Ashtray, rear 105
- Power outlet 105

**Loading and transporting:**

- Ski bag 106
- Cargo area 107
- Cargo loading 110
- Roof-mounted luggage rack 111

**Maintenance and care****Special operating instructions:**

- Break-in procedures 114
- Driving notes 115
- Catalytic converter 115
- Antilock Brake System (ABS) 116
- Disc brakes 118
- Brake system 120
- Winter operation 121
- Power steering 123
- Cellular phone 123
- Radio reception 123

**Wheels and tires:**

- Tire inflation pressure 124
- Tire condition 124
- Tire replacement 125
- Tire rotation 126
- Wheel and tire combinations 127
- Winter tires 128
- Snow chains 128
- Approved wheel and tire specifications 129

**Under the hood:**

- Hood 130
- Engine compartment 132
- Washer fluids 134
- Washer nozzles 134
- Engine oil 135
- Coolant 137
- Brake fluid 138
- Vehicle Identification Number 139

**Care and maintenance:**

- The BMW Maintenance System 140
- Caring for your vehicle 141
- Airbags 147
- Vehicle storage 147

**Laws and regulations:**

- Technical modifications to the vehicle 148
- California Proposition 65 Warning 148
- OBD interface socket 149

# Contents

## Owner service procedures

### Replacement procedures:

- Onboard tool kit [152](#)
- Windshield wiper blades [152](#)
- Lamps and bulbs [153](#)
- Changing a wheel [159](#)
- Battery [162](#)
- Fuses [164](#)
- Microfilter/Activated-charcoal filter [165](#)

### In case of electrical malfunction:

- Fuel filler door [166](#)
- Sliding/Tilt sunroof [166](#)
- Tailgate [166](#)

### Assistance, giving and receiving:

- Jump-starting [167](#)
- Towing the vehicle [168](#)

## Advanced technology

- Airbags [172](#)
- Adaptive Transmission Control (ATC) [173](#)
- Automatic Stability Control plus Traction (ASC+T)/Dynamic Stability Control (DSC) [173](#)
- Radio reception [174](#)
- Four-wheel drive [175](#)
- Safety belt tensioner [175](#)
- Interior rearview mirror with automatic dimmer [176](#)
- Rain sensor [177](#)
- Tire Pressure Control (RDC) [178](#)
- Self-diagnostics [179](#)
- Xenon lamps [180](#)

## Technical data

- Engine data [184](#)
- Dimensions [185](#)
- Weights [186](#)
- Capacities [187](#)
- Electrical system [188](#)
- Drive belts [188](#)

**Index**

- Everything from A to Z 192
- Owner service procedures 198





Cockpit 16  
 Instrument cluster 18  
 Indicator and warning lamps 20  
 Multifunction steering wheel (MFL) 24  
 Sports steering wheel 25  
 Hazard warning flashers 26  
 Warning triangle 26  
 First-aid kit 26  
 Refueling 27  
 Fuel specifications 28  
 Tire inflation pressure 28

## Overview

### Controls and features

### Operation, care and maintenance

### Owner service procedures

### Advanced technology

### Technical data

## Index

## 16 Cockpit

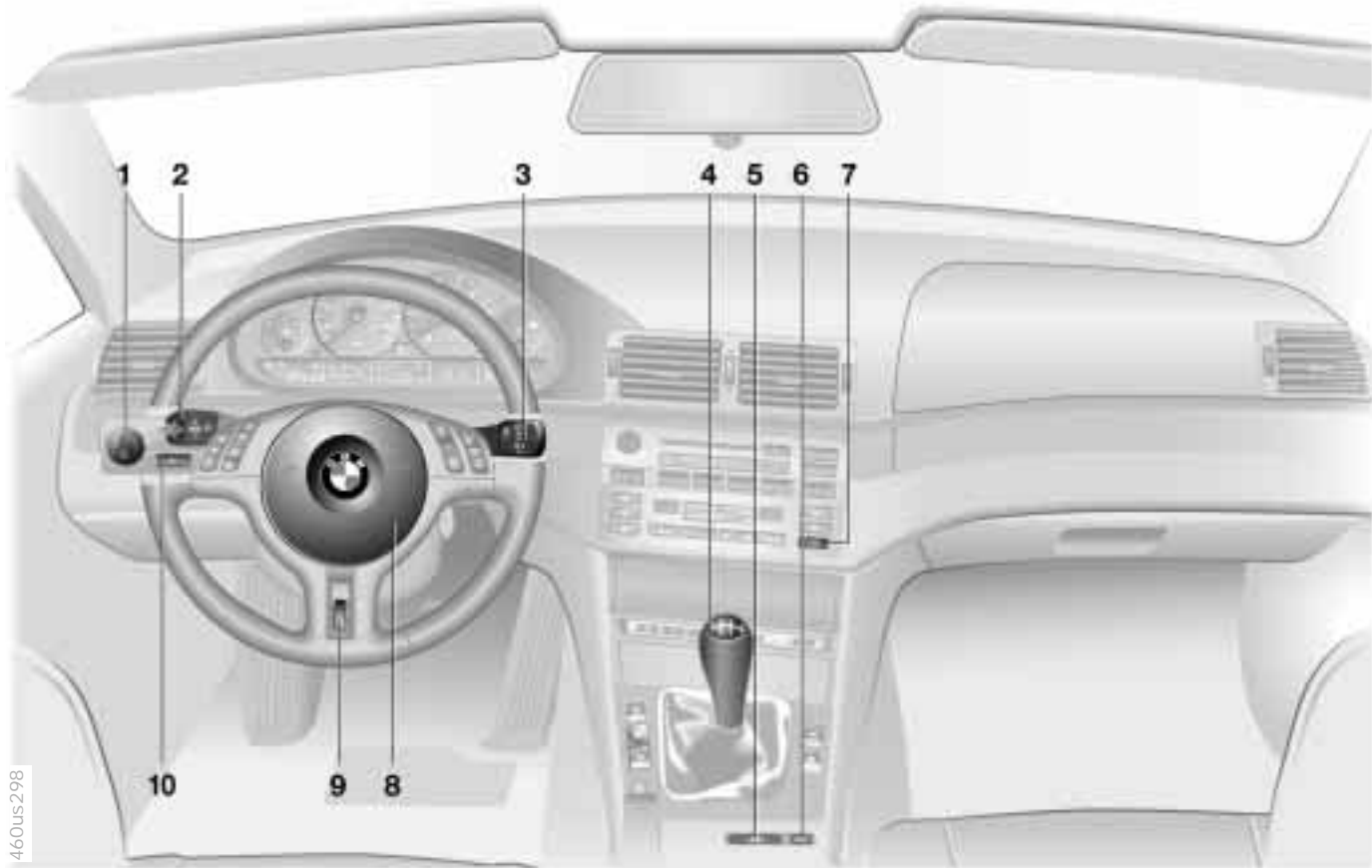



- 1 Parking lamps/Low beams [87](#)
- 2 ▷ Turn signal indicator [68](#)
  - ▷ Parking lamps [88](#)
  - ▷ High beams [88](#)
  - ▷ Headlamp flasher [68](#)
  - ▷ Computer\* [76](#)
- 3 Washer/Wiper system [68](#)
- 4 Shift lever/Selector lever\* [64](#)

For vehicles equipped with manual transmission:  
To engage reverse gear, press the lever to the left and overcome the slight resistance you will encounter
- 5 Hazard warning flashers [26](#)
- 6 Central locking system [34](#)
- 7 Rear window defroster [70](#)
- 8 Horn sports steering wheel\*: the entire surface
- 9 Adjusting steering wheel [50](#)
- 10 Fog lamps\* [88](#)

## 18 Instrument cluster



## Instrument cluster

- 1 Fuel gauge with indicator lamp for fuel reserve [74](#)
- 2 Turn signal indicator [23](#)
- 3 Speedometer
- 4 Indicator lamp for:
  - ▷ Battery charge current [20](#)
  - ▷ High beams [23](#)
  - ▷ Engine oil pressure/Engine oil level [20, 22](#)
- 5 Tachometer and Energy Control [73](#)
- 6 Engine coolant temperature gauge with "Coolant temperature too high" indicator [74](#)
- 7 Indicator and warning lamps (clockwise) for:
  - ▷ Parking brake/Brake hydraulic system/Cornering Brake Control (CBC)/(DBC) [20, 21](#)
  - ▷ Antilock Brake System (ABS) [22](#)
  - ▷ Brake pads [22](#)
  - ▷ Tire Pressure Control (RDC) [20, 22](#)
  - ▷ Airbags [21](#)
  - ▷ Please fasten safety belts [21](#)
  - ▷ Cruise control\* [23](#)
- 8 Adjusting knob for the clock [75](#)
- 9 Program display for automatic transmission [65, 67](#)  
Indicator lamp for automatic transmission [21, 65, 67](#)
- 10 Indicator lamp for Automatic Stability Control plus Traction (ASC+T)/Dynamic Stability Control (DSC) or DSC and ADB/ADB-X [22](#)
- 11 Indicator for:
  - ▷ Odometer [73](#)
  - ▷ Trip odometer [73](#)
  - ▷ Clock [75](#)
  - ▷ Service Interval [74](#)

Display for computer, operation via the turn signal lever, refer to page [76](#):

  - ▷ Clock
  - ▷ Outside temperature
  - ▷ Average fuel consumption
  - ▷ Cruising range
  - ▷ Average speed
- 12 Indicator for Check Control [75](#)
- 13 Trip odometer, reset to zero [73](#)

- 14 Indicator and warning lamps (clockwise) for:
  - ▷ Fog lamps [23](#)
  - ▷ Add washer fluid [22](#)
  - ▷ Coolant level [23](#)
  - ▷ Electronic Throttle Control (EML)\* [23](#)
  - ▷ Service engine soon [23](#)



You can display the outside temperature and distance driven in different units of measurement. ◀

### Technology that monitors itself

Many of the systems of your BMW monitor themselves automatically, both during engine starts and while you are driving. Indicator and warning lamps that are identified by "●" are tested for proper functioning whenever the ignition key is turned. They each light up once for different periods of time.

If a fault should occur in one of these systems, the corresponding lamp does not go out after the engine is started or it will light up while the vehicle is moving. You will see how to react to this below.

### Red: stop immediately



**Battery charge current ●**  
The battery is no longer being charged. There is a malfunction of the alternator V-belt or in the charging circuit of the alternator. Please contact the nearest BMW center.



If the V-belt is defective, do not continue driving. The engine could be damaged due to overheating. If the V-belt is defective, increased steering effort is also required. ◀



**Engine oil pressure ●**  
Stop the vehicle immediately and switch off the engine. Check the engine oil level and refill as required. If the oil level is correct, please contact the nearest BMW center.



Do not continue driving, otherwise, the engine could be damaged because of inadequate lubrication. ◀



**Tire Pressure Control (RDC) ●**  
In addition, an acoustic signal will go off: a tire failure has occurred. Reduce vehicle speed immediately and stop the vehicle. Avoid hard brake applications. Do not oversteer. For additional information, refer to page [85](#).



**Brake warning lamp ●**  
If the lamp comes on when the parking brake is not engaged, check the brake fluid level. Before driving further, be sure to read the notes on pages [122](#) and [138](#).



**Brake warning lamp for Canadian models.**

# Indicator and warning lamps

## Red and yellow: continue driving cautiously



If the brake warning lamp comes on together with the yellow indicator lamps for ABS and ASC+T/DSC:



Then the entire ABS, CBC, ASC+T/DSC and ADB/ADB-X/DBC control system has failed.



Continue driving cautiously and defensively. Avoid hard brake applications. Please have the system checked by your BMW center as soon as possible.

For additional information, refer to pages [79](#), [80](#).



CBC, ABS, ASC+T/DSC and ADB/ADB-X/DBC indicator and warning lamps for Canadian models.



## Red: an important reminder



Brake warning lamp

Comes on when the parking brake is applied – an additional acoustic signal sounds when starting off.

For additional information, refer to page [63](#).



Brake warning lamp for Canadian models.



Please fasten safety belts ●

A warning signal will sound at the same time. Lights up for a few seconds or until the safety belt is fastened.

For additional information on safety belts, refer to page [53](#).



Airbags ●

Please have the system inspected by your BMW center.

For additional information, refer to pages [55](#), [172](#).

## Orange: consult the nearest BMW center



Automatic transmission

Because of a malfunction, the automatic transmission shifts only in the emergency program. Please consult the nearest BMW center.

For additional information, refer to pages [65](#), [67](#).

## 22 Indicator and warning lamps

### Yellow: check as soon as possible



Antilock Brake System (ABS) ●  
ABS has been deactivated in response to system malfunction.

Conventional braking efficiency is available without limitations. Please have the system inspected by your BMW center.

For additional information, refer to page [117](#).



ABS warning lamp for Canadian models.



Engine oil level

Comes on while driving: the oil level is at the absolute minimum; refill as soon as possible. Do not drive more than approx. 30 miles (50 km) until you add oil.

For additional information, refer to page [135](#).



Engine oil level

Comes on after the engine has been shut off: add oil at the earliest opportunity (when you stop to refuel).

For additional information, refer to page [135](#)



Brake pads ●

Have the brake pads checked.

For additional information, refer to page [120](#).



Tire Pressure Control (RDC) ●  
Check the tire pressure. Refer to pages [28](#) and [85](#).



Automatic Stability Control plus Traction (ASC+T)/Dynamic Stability Control (DSC) ●

Indicator lamp flashes:

The system is active and governs drive force and braking force.

The indicator lamp remains on:

ASC+T has been switched off via the button or it is defective, or the DSC has been switched off, the ADB is operational.

In the event of a fault, please consult the nearest BMW center.

For additional information, refer page [79](#).

BMW 325xi:

The DSC has been either turned off or is defective. ADB-X is in ready mode. If the warning lamp does not go out after pressing the DSC button repeatedly, then the both the DSC and ADB-X are defective.

Please consult the nearest BMW center.

For additional information, refer to page [80](#).



Automatic Stability Control plus Traction (ASC+T)/Dynamic Stability Control (DSC) and brake warning lamp ●



The indicator lamps remain on: The DSC and ADB/DBC are

switched off by means of the button or are defective.

Please consult the nearest BMW center.

For additional information, refer to page [79](#).

BMW 325xi:

DSC and ADB-X are defective.

ADB-X cannot be switched off.

Please consult the nearest BMW center.

For additional information, refer to page [83](#).



DSC and ADB/ADB-X/DBC indicator and warning lamps for Canadian models.



Add washer fluid

The washer fluid level is too low. Top up at the earliest opportunity.

For additional information, refer to page [134](#).

## Indicator and warning lamps



### Service Engine Soon ●

If the indicator lamp comes on either continuously or intermittently, this indicates a fault in the emissions-related electronic systems.

Although the vehicle remains operational, you should have the systems checked by your BMW center at the earliest possible opportunity.

For additional information, refer to page [149](#).



Service Engine Soon warning lamp for Canadian models.



### Engine electronics\*

There is a fault in the engine's electronic control system. The electronics allow for continued driving with reduced engine output or rpms. Please have the system inspected by your BMW center.



### Add coolant

The coolant level is too low. Top off the coolant at the earliest opportunity.

For additional information, refer to page [137](#).

### Green: for your information



#### Turn signal indicator

Flashes when the turn signal is operated. Rapid flashing indicates a system malfunction.

For additional information, refer to page [68](#).



#### Cruise control

Comes on when the cruise control is activated. Available for operation via the multifunction steering wheel.

For additional information, refer to page [71](#).



#### Fog lamps

Comes on whenever you switch on the fog lamps.

For additional information, refer to page [88](#).

### Blue: for your information



#### High beams

Comes on when the high beams are on or the headlamp flasher is actuated.

For additional information, refer to pages [68](#), [88](#).

## 24 Multifunction steering wheel (MFL)

The controls integrated in the multifunction steering wheel (MFL) are provided so that you can operate a number of accessories quickly and without being distracted from traffic conditions. You can operate:

- ▷ Selected radio functions,
- ▷ the cruise control,
- ▷ selected cellular phone functions.

 In order to operate a system via the MFL, the corresponding system controls must be activated. ◀

Refer to the individual accessory manuals for more detailed descriptions.



- 1 Press briefly:  
Receive a call, start dialing, terminate a call  
Press longer:  
Voice recognition\*: switch on and off
- 2 Radio/Cellular phone: select
- 3 Radio/Cellular phone: scan backward or scan station keys or scroll through the phone listings
- 4 Radio/Cellular phone: volume
- 5 Radio/Cellular phone: scan forward or scan station keys or scroll through the phone listings
- 6 Horn: the entire surface
- 7 Cruise control: resume stored setting
- 8 Cruise control: store and accelerate (+); decelerate and store (-)
- 9 Cruise control: activate/interrupt/deactivate



## Sports steering wheel\*

The controls integrated in the sports steering wheel are provided so that you can operate a number of accessories quickly and without being distracted from traffic conditions.

You can operate:

- ▷ Selected radio functions,
- ▷ the cruise control,
- ▷ selected cellular phone functions.

 In order to operate a system via the sports steering wheel, the corresponding system controls must be activated. ◀

Refer to the individual accessory manuals for more detailed descriptions.

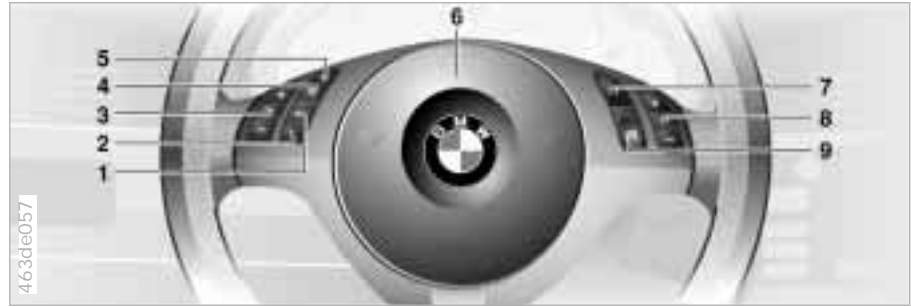

- |   |  |
|---|--|
| 1 Radio/Cellular phone: select  | 6 Horn: the entire surface   |
| 2 Press briefly:<br>Receive a call, start dialing, terminate a call<br>Press longer:<br>Voice recognition*: switch on and off | 7 Cruise control: resume stored setting                              |
| 3 Radio/Cellular phone: volume  | 8 Cruise control: store and accelerate (+); decelerate and store (-) |
| 4 Radio/Cellular phone: scan backward or scan station keys or scroll through the phone listings                               | 9 Cruise control: activate/interrupt/deactivate                      |
| 5 Radio/Cellular phone: scan forward or scan station keys or scroll through the phone listings                                |  |

## 26 Hazard warning flashers



The button flashes intermittently when the hazard flashers are on.

To help you locate the switch in an emergency, the button is also illuminated whenever the vehicle's lamps are on.

 The turn signal indicator function takes priority over the hazard warning function. This means that with the ignition key in position 1, you can still use the turn signal indicator function, even if the hazard warning flashers are being used at the same time. ◀

## Warning triangle\*



The hazard warning triangle is stored on the left-hand side of the luggage compartment behind the cover panel.

To open: press the button (arrow) and remove the cover.

 Comply with legal requirements for keeping a hazard warning triangle in the vehicle. ◀

## First-aid kit\*



The first-aid kit is located under the front passenger's seat.

To open: pull the handle and fold the cover down.

To close: fold the cover up.

 Some of the articles in the first-aid kit may be used within a limited time only. For this reason, check the expiration dates of each of the items regularly, and replace any with passed dates. You can acquire replacements in any drugstore or pharmacy. Comply with legal requirements for keeping a first-aid kit in the vehicle. ◀



## Fuel filler door

 Before filling the tank, shut off the engine. If you do not, fuel cannot flow into the tank and the Service Engine Soon lamp may come on. ◀

Press on the rear edge of the fuel filler door to open and close it.

To unlock the fuel filler door if the central locking system malfunctions, refer to page [166](#).

 When handling fuels, comply with all of the applicable safety precautions and regulations pertaining to fuels. Never carry spare fuel containers in your vehicle. Whether empty or full, these containers can leak, cause an explosion, or lead to fire in the event of a collision. ◀



## Simple and environmentally friendly

 Open the filler cap carefully to prevent fuel from spraying out. Fuel spray may cause injury. ◀

Place the filler cap in the bracket attached to the fuel filler door.

When refueling, insert the filler nozzle completely into the filler pipe. Pulling the nozzle out of the pipe during refueling

- ▷ results in premature pump shutoff
- ▷ and will reduce the effect of the vapor recovery system on the pump.

If the filler nozzle is operated correctly, the fuel tank will be full when it shuts off for the first time.

Tank capacity: refer to page [187](#).

 Close the filler cap carefully after refueling until a "click" is heard. While closing, be sure not to squeeze the strap which is fastened to the cap. A loose or missing cap will activate the Service Engine Soon lamp. ◀

## 28 Fuel specifications

The engine uses lead-free gasoline only.

Required fuel:

Premium Unleaded Gasoline,  
min. 91 AKI

AKI = Anti Knock Index

 Do not use leaded fuels. The use of leaded fuels will cause permanent damage to the system's oxygen sensor and the catalytic converter. ◀

## Tire inflation pressure



 Check tire inflation pressures – including the space-saver spare wheel, or spare wheel – regularly, at least every two weeks and before beginning any extended driving. Incorrect tire pressure can otherwise lead to tire damage and accidents. Inflate the spare tire to the highest tire inflation pressure specified for your vehicle. ◀

You will find the inflation pressures on the inside door pillar (visible with door open).

### Check tire pressures

On the next page you will find all the tire pressure and ambient air temperature specifications stated in the units usually used in your country (psi; kilopascal).

For vehicles with Tire Pressure Control (RDC):



After correcting the tire inflation pressure, reactivate the system. Refer to page [85](#).

# Tire inflation pressure

## Observe tire approval specifications

The inflation pressures in the table apply to tires made by BMW-approved manufacturers. Your BMW center is familiar with these pressures. Higher pressures may be specified for tires made by other manufacturers. You will find a list of approved tires beginning on page [129](#).

Your vehicle is equipped with tires that meet US and European standards. We recommend the exclusive use of BMW-approved tires.

BMW	Tires All pressure specifications in the table are indicated in psi (kilopascal) for cold tires (cold = ambient temperature)				
	All summer tires and the all season tire 205/55 R 16 91 H M+S	32 (220)	38 (260)	38 (260)	45 (310)
325 325xi	All winter tires and the all season tire 205/50 R 17 93 V M+S	35 (240)	41 (280)	41 (280)	48 (330)
	Space-saver tire in the luggage compartment				61 (420)

For all season tires use the same inflation pressure as for summer tires.

For extra load tires 205/50 R 17 93 W use the same tire inflation pressure as for winter tires.

**Opening and closing:**

Keys 32

Electronic vehicle  
immobilizer 33

Central locking system 34

Opening and closing –  
from the outside 34

Opening and closing –  
from the inside 38

Tailgate 39

Cargo area 40

Alarm system 41

Electric power windows 43

Sliding/tilt sunroof 44

**Adjustments:**

Seats 46

Seat and mirror memory 49

Steering wheel 50

Mirrors 51

Car Memory, Key Memory 52

**Passenger safety systems:**

Safety belts 53

Airbags 55

Transporting children safely 58



**Driving:**

- Steering/Ignition lock 61
- Starting the engine 61
- Switching off the engine 62
- Parking brake 63
- Manual transmission 64
- Automatic transmission
  - with Steptronic 65
- Turn signal indicator/Headlamp
  - flasher 68
- Washer/Wiper system 68
- Rear window defroster 70
- Cruise control 71

**Everything under control:**

- Odometer 73
- Tachometer 73
- Energy Control 73
- Fuel gauge 74
- Coolant temperature gauge 74
- Service Interval Display 74
- Check Control 75
- Clock 75
- Computer 76

**Technology for safety and driving convenience:**

- Park Distance Control (PDC) 78
- Automatic Stability Control plus
  - Traction (ASC+T) 79
- Dynamic Stability Control
  - (DSC) 80
- Tire Pressure Control (RDC) 85

**Lamps:**

- Side lamps/Low beams 87
- Instrument lighting 87
- High beams/Parking lamps 88
- Fog lamps 88
- Interior lamps 88

**Controlling the climate for pleasant driving:**

- Air conditioner 90
- Automatic climate control 96
- Seat heating 100

**Cabin convenience:**

- HiFi system 101
- Glove compartment 101
- Storage compartments 102
- Cellular phone 103
- Ashtray, front 104
- Cigarette lighter 104
- Ashtray, rear 105
- Power outlet 105

**Loading and transporting:**

- Ski bag 106
- Cargo area 107
- Cargo loading 110
- Roof-mounted luggage rack 111

**Overview****Controls and features****Operation, care and maintenance****Owner service procedures****Advanced technology****Technical data****Index**

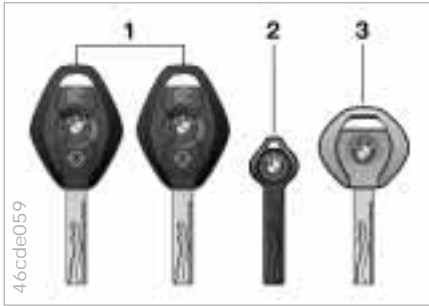

1 The master keys with remote control determine the functions for the Key Memory; refer to page [52](#)

 There is an extended-life battery in every master key that is charged automatically in the steering lock as you drive.

For this reason, if you have a master key that is otherwise not used, use that key at least once every year while driving for an extended period to charge the battery. Refer also to page [35](#). ◀

2 Spare key for storage in a safe place, such as in your wallet. This key is not intended for constant use

3 Door and ignition key

The lock for the glove compartment cannot be operated with this key, which is an advantage when using for valet parking, for instance

### Replacement keys

Replacement keys are available exclusively through your authorized BMW center. Since the keys belong to a security system, your BMW center is obligated to ensure that a person requesting a key is authorized to do so (refer to "Electronic vehicle immobilizer" on page [35](#)).

 If possible, take all of the master keys that belong to the vehicle with you when you pick up your replacement key. Whenever you receive a new replacement key, turn that key to position 2 in the ignition lock once (ignition switched on) and then back. This allows the electronic vehicle immobilizer to "learn" the new key. ◀



# Electronic vehicle immobilizer



## How the electronics work

At the heart of this system is an electronic chip that is integrated into the key. The lock mechanism itself is actually a dual-function device. While the engine is running, the circuitry in the ignition key and the vehicle's electronic system constantly exchange variable, vehicle-specific signals. The system will not release the ignition, fuel injection and starter unless it recognizes an "authorized" key.

## The key to security

Your BMW is equipped with a passive anti-theft system. This electronic immobilization system reduces the likelihood of your vehicle being stolen by making it impossible to start the engine using any keys other than the ones furnished with the vehicle. Your BMW center can cancel the electronic system authorization for individual keys (in the event of loss, for instance). A deactivated key can no longer be used to start the engine.

 Force applied to the key can damage the integrated electronic circuitry. A damaged key can no longer be used to start the engine. ◀

**The concept**

The central locking system is ready for operation whenever the driver's door is closed. The system engages and releases the locks on the

- ▷ doors
- ▷ tailgate and rear window
- ▷ fuel filler door.

The central locking system can be operated

- ▷ from outside via the door lock and using the remote control
- ▷ from inside by pressing a button.

Activating the central locking system from inside does not lock the fuel filler door (see page 38). When it is actuated from the outside, the anti-theft system is activated simultaneously. Both the door locks and release handles remain locked. The alarm system is also armed or disarmed.

If locked from the inside, the central locking system unlocks automatically in the event of an accident. But the system only unlocks those doors that were not locked separately using the safety buttons, refer to page 38. In addition, the hazard warning flashers and interior lamps come on.

**Using the key**

One turn of the key in the driver's door lock unlocks the driver's door only. Turning the key a second time unlocks all of the remaining doors, the tailgate and the fuel filler door.



You can have a signal set as an acknowledgment message that the vehicle is closed correctly. ◀

**Convenience operation**

You can also operate the power windows and sliding/tilt sunroof via the door lock.

- ▷ To open: if the door is closed, hold the key firmly in the "Unlock" position.
- ▷ To close: if the door is closed, hold the key firmly in the "Lock" position.



Watch during the closing process to be sure that nobody is inadvertently injured. Releasing the key stops the operation. ◀

**Manual operation**

(in the event of an electrical malfunction)

Turn the key to the extreme left or right to unlock/lock the door.

## Opening and closing – from the outside

### Using the remote control

The remote control gives you an exceptionally convenient method for unlocking and locking your vehicle. Furthermore, it provides two additional functions that only the remote control can execute:

- ▷ Switching on the interior lamps, refer to page 38.  
With this function, you can also "search for" your car – when parked in an underground garage, for instance.
- ▷ Opening the rear window, refer to page 39.  
The rear window will open slightly, regardless of whether it was previously locked or unlocked.

When you unlock the vehicle, the anti-theft system is deactivated, the alarm system is disarmed, and the interior lamps are turned on. When you lock the vehicle, the systems are activated and armed, and the lamps go off.

 You can have a signal set as an acknowledgment message that the vehicle is closed correctly. ◀



### Master keys

Keys with remote control are master keys. Refer to page 32.

 Children might be able to lock the doors from the inside. For this reason, always take the vehicle's keys with you so that the vehicle can be opened again from the outside at any time. ◀

 Master keys that are used repeatedly are always ready for operation since the battery in the key is charged automatically in the steering lock as you drive.

If it is no longer possible to unlock the vehicle via the remote control, the battery is discharged. Use this key while driving for an extended period in order to recharge the battery. Refer also to page 32.

To prevent unauthorized use of the remote control, surrender only the door and ignition key or the spare key (refer to page 32) when leaving the vehicle for valet parking, for example.

In the event of a system malfunction, please contact your BMW center. You can also obtain replacement keys there. ◀

## 36 Opening and closing – from the outside



### To unlock the vehicle

Press button 1.

Press the button once to unlock the driver's door only; press a second time to unlock all remaining doors as well as the rear window and fuel filler door.

### Convenience opening mode

Press and hold button 1. The power windows and sliding/tilt sunroof are opened.



### Locking and securing

Press button 2.



### Turning on the interior lamps

After locking the vehicle, press button 2 again.

### Switching off the tilt alarm sensor\* and interior motion sensor\*

Press button 2 again immediately after locking.

For additional information, refer to page [42](#).

## Opening and closing – from the outside



### Opening the rear window

Press button 3.

The rear window opens slightly. It can now be tilted up.

 Before and after a trip, be sure that the rear window was not opened unintentionally. ◀

### Panic mode (trigger alarm)

By pressing button 3 for 2 to 5 seconds, the alarm can be sounded in the event of danger, if the alarm system is armed. Pressing on button 1 will turn the alarm off.

The LED (light-emitting diode) will light up briefly whenever you press on the individual buttons.

### System interference

External systems or devices may cause local interference in the functions of the remote control.

If this should occur, you can unlock and lock the vehicle via the door lock with a master key.

### For US owners only

The transmitter and receiver units comply with part 15 of the FCC (Federal Communication Commission) regulations. Operation is governed by the following:

FCC ID: LX8EWS  
LX8FZVS  
LX8FZVE

Compliance statement:

This device complies with part 15 of the FCC Rules. Operation is subject to the following two conditions:

- ▷ This device may not cause harmful interference, and
- ▷ this device must accept any interference received, including interference that may cause undesired operation.

 Any unauthorized modifications or changes to these devices could void the user's authority to operate this equipment. ◀

## 38 Opening and closing – from the inside



Use this button to operate the central locking system when the front doors are closed. The doors and tailgate are unlocked or locked only. The anti-theft alarm system is not activated.

 If only the driver's door was unlocked from the outside and you press on the button, then all the other doors, tailgate and rear window as well as the fuel filler door will unlock if the driver's door is open. If the driver's door is closed it will be locked. ◀

 The central locking system can be locked automatically as soon as you begin to drive if you desire. You may also have this adjusted so that it is specific to keys. ◀

### To unlock and open the doors

- ▷ Either unlock the doors together with the button for the central locking system and then pull each of the release handles above the armrests, or
- ▷ pull the release handle for each door twice: the first pull unlocks the door, and the second one opens it.

### To engage locks

- ▷ Use the central locking button to lock all of the doors simultaneously, or
- ▷ press the individual safety lock buttons down. The fuel filler door then remains unlocked. As an added design feature to prevent the driver from being inadvertently locked out of the vehicle, the driver's door safety lock button will not engage as long as the door is open.

 Children might be able to lock the doors from the inside. For this reason, take the vehicle's keys with you so that the vehicle can be opened again from the outside at any time. ◀

# Tailgate

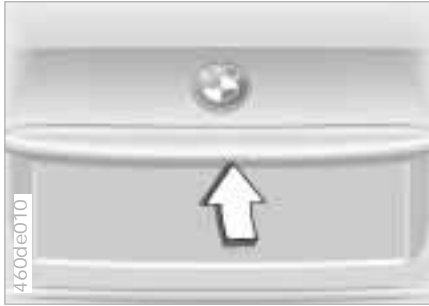

## Opening from outside

Press the button in the handle recess (arrow): the tailgate opens slightly.

The luggage compartment lamp goes on when the tailgate is opened.

For opening manually in the event of an electrical malfunction, refer to page [166](#).

Opening from the inside, refer to page [38](#).

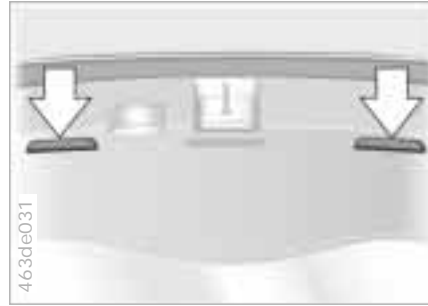

## Closing

The handle recesses in the interior trim panel of the tailgate (arrows) make it easier to pull down.

 Before and after a trip, be sure that the rear window was not opened unintentionally. ◀

 To avoid injuries, be sure that the travel path of the tailgate lid is clear when it is closed, as with all closing procedures. ◀

 Operate the vehicle only when the tailgate or rear window is completely closed so that no exhaust fumes penetrate the interior of the vehicle. If it should happen that the tailgate or rear window are left open while driving:

- ▷ Close all windows, including the sliding/tilt sunroof.
- ▷ Increase the air supply for the air conditioner or automatic climate control to a high level. Refer to page [90](#) or [96](#). ◀



### Opening the rear window

Small items can be loaded or unloaded quickly if the rear window is opened separately.

Press the button (arrow): the rear window opens slightly. It can now be tilted up.

Push the window down to close it.

 If pointed or sharp-edged objects could hit the rear window while driving, be sure to provide protection around all edges, otherwise, the heating conductors for the rear window could be damaged. ◀

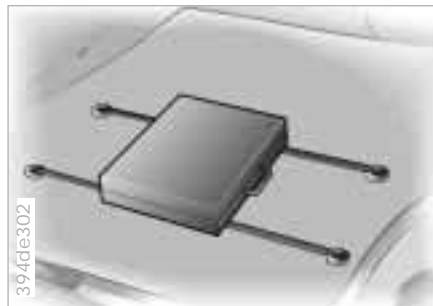

### Luggage straps

Use the retaining straps on the cargo area floor to secure smaller items of luggage.

Movement is reduced when objects are placed on the straps.

To attach the luggage nets\* or elastic straps in order to keep luggage securely in place, you will find lashing eyes on the inside corners of the luggage compartment.

Refer also to "Cargo loading" on page [110](#).

For the roll-up cover and other features in the cargo area, refer to "Cargo area" beginning on page [107](#).



# Alarm system\*

## The concept

The vehicle alarm system responds:

- ▷ When a door, the hood or the tailgate is opened.
- ▷ To movement inside the vehicle (interior motion sensor).
- ▷ To a change of the vehicle's tilt – if someone attempts to steal the wheels or tow the vehicle without authorization, for example.
- ▷ To interruption of battery voltage.

The system responds to unauthorized vehicle entry and attempted theft by simultaneously activating the following:

- ▷ Sounding an acoustical alarm for 30 seconds.
- ▷ Activating the hazard warning flashers for approx. five minutes.
- ▷ Flashing the high beams flash on and off in rhythm with the hazard warning flashers.

## To activate and deactivate the alarm system

When the vehicle is locked or unlocked by using a key or the remote control, the alarm system is also armed or disarmed at the same time.

The interior motion sensor and tilt alarm sensor are activated 30 seconds after the last locking operation.

If the alarm system has been armed correctly, the hazard warning flashers flash once.

 You can have one signal set as acknowledgment when arming and disarming. ◀

You can also open the rear window when the system is armed by pressing button 3 of the remote control (refer to page 37). When it is closed, the rear window is once again secured.



## Indicator lamp displays

The indicator lamp is located under the inside rearview mirror.

- ▷ The indicator lamp flashes continuously: the system is armed.
- ▷ The indicator lamp flashes when it is armed: doors, the hood, tailgate or rear window have not been properly closed. Even if you do not close the alerted area, the remaining areas are deadlocked, and the indicator lamp flashes continuously after 10 seconds. However, the interior motion sensor is not activated.
- ▷ The indicator lamp goes out when the system is disarmed: no manipulation or attempted intrusions have been detected in the period since the system was armed.

## 42 Alarm system\*

- ▷ The indicator lamp flashes for 10 seconds when the system is disarmed: an attempted entry has been detected in the period since the system was armed.

Following triggering of an alarm, the indicator lamp will flash continuously.

### Avoiding unintentional alarms

The tilt alarm sensor and interior motion sensor may be switched off at the same time. Doing this prevents a false alarm from being triggered (in garages with elevator ramps, for instance), or when the vehicle is transported by trailer or train:

Lock the vehicle (= arm the system) twice. Press button 2 on the remote control twice in succession or lock the vehicle twice with the key (refer to page 36).

The indicator lamp lights up briefly and then flashes continuously. The tilt alarm sensor and the interior motion sensor are deactivated as long as the system is armed.

Reset the alarm system in order to reactivate both the tilt sensor alarm system and interior motion sensor.



### Interior motion sensor

The transmitter and receiver of the interior motion sensor are located in a trim panel in the vehicle's roof.

In order for the interior motion sensor to function properly, the windows and sliding/tilt sunroof must be completely closed.

However, be sure to deactivate the interior motion sensor (refer to the previous column "Avoiding unintentional alarms"), when you wish to leave the windows or the tilt/sunroof open.

# Electric power windows



## Open and close the windows

From ignition key position 1:

- ▷ Press the switch up to but not past the resistance point:  
The window will continue to open as long as you hold the switch.
- ▷ Press the switch past the resistance point:  
The window will move automatically. Pressing the switch again stops the opening cycle.

You can close the windows in the same manner by pulling the switch.

In the rear, there are separate switches under the windows.

After the ignition has been switched off: You can still operate the power windows for up to 15 minutes, as long as neither of the front doors was opened during that time.



Remove the key from the ignition and close the doors when you leave the vehicle, so that children cannot operate the power windows and possibly injure themselves. ◀

For the convenience opening mode with the door lock or remote control, refer to page [34](#) or [35](#).

## Safety feature

A contact strip is located on the inside upper frame of each of the windows. If pressure is exerted against this contact strip while a window is being raised, the system will respond by stopping the window and then retracting it somewhat.





Despite this safety feature, be extremely careful that the closing path of the window is not obstructed whenever it is being closed. Otherwise, an object might not touch the contact strip in some situations (with very thin objects, for instance). You can override this safety feature by pulling the switch beyond the resistance point and holding it. ◀



### **Safety switch**

With the safety switch, you can prevent the rear windows from being opened or closed via the switch in the rear passenger area\* (by children, for instance).

 Press the safety switch whenever children are riding in the rear of the vehicle. Careless use of the power windows can lead to injury. ◀

 Exercise care when closing the sliding/tilt sunroof and keep it in your field of vision until it is completely closed. Failure to do so can result in injuries.

Always remove the key from the ignition and lock the doors when you leave the vehicle so that, for instance, children cannot operate the sunroof and possibly injure themselves. ◀

You can avoid a vacuum or drafts in the passenger compartment whenever the sunroof is open or raised if you keep the air vents in the dashboard open and increase the air supply as needed. Refer to pages [92](#) or [99](#).

If the sunroof is completely open, air disturbances may be caused in the vehicle when you are driving at higher speeds. Close the roof as far as is necessary until this natural phenomenon ceases.

For the convenience opening mode with the door lock or the remote control, refer to page [34](#) or [35](#).



### **Lifting – opening – closing**

From ignition key position 1, press the switch or slide it to the desired direction until you feel resistance.

When lifting, the headliner retracts several inches.

 Do not use force to close the headliner when the sunroof is open, or you could damage the mechanism. ◀

After the ignition has been switched off, you can still operate the sunroof for up to 15 minutes, as long as neither of the front doors was opened during that time.

## Sliding/tilt sunroof

### Automatic opening and closing

- ▷ Press the switch past the resistance point: the sunroof travels to either the fully-closed or fully-opened position.
- ▷ With the sunroof open, press the switch briefly toward "Raise": the roof will move into the end "Raise" position.

Pressing the switch again stops operation immediately.

### Safety feature

If the sliding/tilt sunroof encounters resistance at a point roughly past the middle of its travel when it is closing, the closing cycle is interrupted and the sunroof will open again slightly.



Despite this safety feature, be extremely careful that the closing path of the sunroof is not obstructed whenever it is closed. Otherwise, triggering the closing-force limitation may not be ensured in some situations (with very thin objects, for instance). You can disable this safety feature by pressing the switch beyond the pressure point and holding it. ◀

### Power loss or malfunction

In the event of an electrical system malfunction, the sliding/tilt sunroof can be operated manually. Refer to page [166](#).

## 46 Seat adjustment

For maximum safety when adjusting the seat position, please observe the following:

 Never try to adjust your seat while driving the vehicle. The seat could respond with an unexpected movement, and the ensuing loss of vehicle control could lead to an accident. Be sure that the safety belt remains firmly against your body at all times. In the event of a frontal impact, a loose lap belt could slide over the hips, leading to abdominal injury. In addition, the safety belt's restraint effectiveness is reduced if the belt is worn loosely. While driving, do not recline the backrest too far (this applies to the passenger side especially), because otherwise there is the danger of sliding underneath the safety belt during an accident, thereby negating the safety belt's protection. ◀

### Correct sitting posture

To reduce strain on the spinal column, sit all the way back in the seat and rest your back fully against the backrest. The ideal sitting posture is when your head forms a straight line with your spine.

For long-distance driving, you may wish to increase the backrest angle slightly to reduce muscular tension. You should be able to grasp the steering wheel at its highest point with your arms slightly bent.

After a seat adjustment, adjust the height of the safety belt also. Refer to page 53.

## Mechanical seat



- 1 Backward/forward adjustment  
Pull the lever and slide the seat to the desired position.  
After releasing the lever, apply pressure to the cushion to ensure that the latch engages securely
- 2 Cushion height  
Pull the lever and apply weight to or remove weight from the seat as required



### 3 Backrest angle

Pull the lever and apply weight to or remove weight from the backrest to reach the desired position

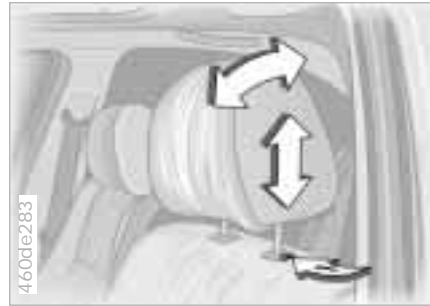

### Adjustments

Height: adjust by pulling or applying pressure.

 In order to move to the lowest positions, press button 1. ◀

To adjust the angle of the front head restraints:  
Adjust by tilting the head restraint.

 Head restraints reduce the risk of injury to the cervical vertebra during an accident.  
Adjust the head restraint so that its center is approximately at the height of the ear. ◀



### Removal

- ▷ Pull the head restraint upward to the stop.
- ▷ Press the button (arrow) and remove the head restraint.

### Installation

- ▷ Press the button (arrow) and insert the head restraint into the guides.
- ▷ Adjust the head restraint.

## 48 BMW sports seat\*



With this seat, you can also adjust the tilt angle and the thigh support:

- 1 Tilt angle upward:  
Pull the lever as often as necessary to reach the desired angle
- 2 Tilt angle downward:  
Push the lever as often as necessary to reach the desired angle
- 3 Thigh support area:  
Pull the lever and adjust the position of the cushion for thigh support as desired

## Lumbar support\*



You can adjust the backrest's contour for additional support in the curvature of your spine's lumbar region.

The upper hips and spinal column receive supplementary support to help you maintain a relaxed, upright posture.

- ▷ Press front/rear of switch:  
Increase/decrease curvature.
- ▷ Press the upper/lower end of the switch:  
Increase the upper/lower curvature.

## Power seat\*



- 1 Backward/forward adjustment
- 2 Cushion height
- 3 Backrest angle

The head restraint is adjusted manually.

 Comply with the adjustment instructions on page 46. Failure to do so could result in diminished personal safety. ◀





### BMW sports seat

- 1 Tilt angle
- 2 Backward/forward adjustment
- 3 Cushion height
- 4 Backrest angle

Adjust the head restraints (refer to page 47) and thigh support (refer to page 48) manually.

 Comply with the adjustment instructions on page 46. Failure to do so could result in diminished personal safety. ◀

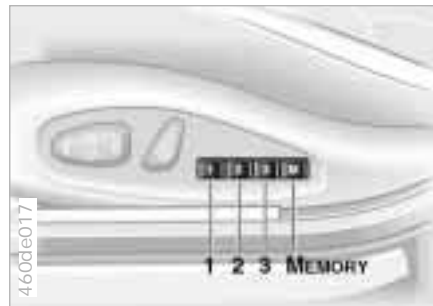

You can store and recall three different driver's seat and outside mirror positions.

The adjustment setting for the lumbar support is not saved in memory. ◀

### To store

- 1 Turn the key to ignition key position 1 or 2.
- 2 Adjust your seat and outside mirrors to the desired position.
- 3 Press the **MEMORY** button: the indicator lamp in the button lights up.
- 4 Press memory button 1, 2 or 3, as desired. Indicator lamp goes out.

### To select a stored setting

Convenience function:

- 1 The driver's door remains open after unlocking or the ignition key is in position 1.
- 2 Briefly press memory button 1, 2 or 3, as desired.

The adjustment cycle is canceled immediately if you press a seat adjustment switch or one of the memory buttons.

Security function:

- 1 The driver's door is closed and the ignition key is either removed or in position 0 or 2.
- 2 Maintain pressure on the desired memory button 1, 2 or 3 until the adjustment process is completed.

If you press the **MEMORY** button accidentally: press the button again; the indicator lamp goes out.

 Do not select a memory position while the vehicle is moving. If you do so, there is a risk of accident from unexpected seat movement. ◀

## 50 Seat and mirror memory\*



Your BMW center can adjust your vehicle's systems in such a manner that your personalized settings are automatically set for the seat and outside mirror positions when you unlock the vehicle with your personal remote control. ◀



When this setting is used, be sure that the footwell behind the driver's seat is clear before unlocking the vehicle. If you fail to do so, any persons or objects behind the seat could be injured or damaged by a rearward movement of the seat. ◀



### Passenger side exterior mirror tilt function

(automatic curb monitor\*)

- 1 Move the mirror selector switch 1 to the "driver's mirror" position.
- 2 When the selector lever is placed in "Reverse," the passenger-side mirror tilts downward. This allows the driver to see the area directly adjacent to the vehicle during parking (curbs, etc.).

You can deactivate this automatic feature: set mirror-selector switch to the "passenger mirror" position.

## Adjusting steering wheel



- 1 Push the locking lever downward.
- 2 Adjust the steering wheel (fore/aft and up/down) to the desired position.
- 3 Pull the lever back in to clamp the steering wheel in the new position.



Do not adjust the steering wheel while the vehicle is moving. If you do so, there is a risk of accident from unexpected movement. ◀

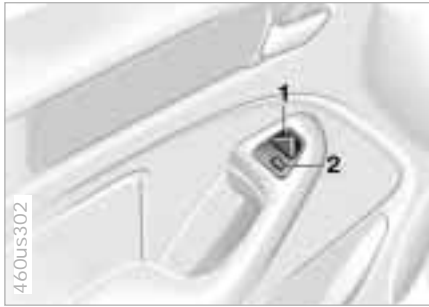

## Exterior mirrors

- 1 Switch for 4-way adjustment
- 2 Button for switching from one mirror to the other

You can also adjust the mirrors manually by pressing against the outer edges of their lenses.



The mirror on the passenger's side features a lens with a more convex surface than the mirror installed on the driver's side. When estimating the distance between yourself and other traffic, bear in mind that the objects reflected in the mirror are closer than they appear. Estimating the distance between you and the traffic behind you is therefore imprecise. ◀

## Electric defrosting

Both mirrors are automatically defrosted with the ignition key in position 2.



## Interior rearview mirror

To reduce glare from vehicles behind you when you are driving at night, tilt the mirror by turning the button.

## Lighted vanity mirrors\*

Fold down the sun visor and slide the cover panel to the side as required. The mirror lamps operate in ignition key positions 1 and 2.

## Sun visors

These can be folded down toward the windshield or swiveled out against the side windows.



### Interior rearview mirror with automatic dimming feature\*

By responding to the effects of ambient light and the glare from following traffic, this mirror automatically dims through an infinitely-variable range.

The mirror switches to its clear, undimmed mode whenever the transmission is placed in reverse gear (selector lever in "Reverse").

For proper functioning of the mirror, be sure that the two photocells are unobstructed and clean. One of the photocells (arrow) is positioned in the mirror's glass, while the other is slightly offset on the opposite side of the mirror.

For an explanation of the electrochromic technology used in this mirror, refer to page 176.

## Car Memory, Key Memory



### How the system functions

You have probably frequently wished that you could configure individual functions of your vehicles to reflect your own personal requirements. In engineering your vehicle, BMW has included several user-defined functions in the vehicle's design. Your BMW center can make these settings for you in accordance with your wishes.

There are settings related to the vehicle ("Car Memory") and settings related to individuals ("Key Memory"). You can have up to four different basic settings adjusted for four different persons. The only requirement is that each person uses his or her own remote control key. When your vehicle is unlocked with the remote control, the vehicle recognizes the individual user by means of a data exchange with the key, and makes

adjustments accordingly. So that you can distinguish among the different keys, colored decals are supplied along with the keys.

### What the system can do

Your authorized BMW center can provide you with details on the capabilities of the Car Memory and Key Memory systems. A few examples follow below:

Examples for Car Memory:

- ▷ Various signals used as acknowledgement when locking or unlocking your vehicle.
- ▷ Deactivating/activating the Follow-Me-Home lamps function.
- ▷ Activating/deactivating daytime running lamps\*.

Examples for Key Memory:

- ▷ Automatically setting the driver's power seat.
- ▷ Locking your vehicle after starting off.

When unlocking your vehicle, first unlock the driver's door, then the rest of the vehicle.

 You will see this symbol throughout the Owner's Manual. It is to remind you at appropriate places of the settings that are available to you. ◀

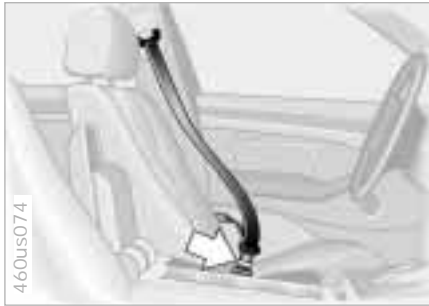

## Drive with your safety belt on

Fasten your safety belt at the beginning of every trip.

To fasten:

Make sure you hear the catch engage in the belt buckle.

To release:

Press the red button in the buckle. Hold the belt and guide it back into its reel.

The two rear safety belt buckles which are integrated in the rear seat are for passengers sitting on the left and right. The belt buckle with the word "CENTER" is intended exclusively for passengers sitting in the middle.

For care instructions, refer to page [144](#).

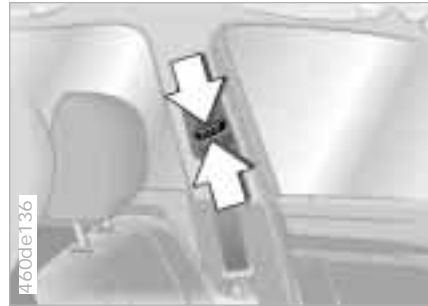

## Safety belt height adjustment

You can adjust the safety belts to fit your own physical dimensions by using the safety belt height adjustment.

Slide the button downward or upward.



For your safety, please comply with the following instructions for wearing safety belts. If you do not, the safety belts may not be able to provide their maximum protection. The following information also applies to your passengers:

Never allow more than one person to wear a single safety belt. Never allow infants or small children to ride in a passenger's lap.

Avoid twisting the belt while routing it firmly across your hips and shoulder. Do not allow the belt to rest against hard or fragile objects in your pockets. Do not route the belt across your neck, or run it across sharp edges. Be sure that the belt does not become caught or jammed.

Be sure that the safety belt fits snugly against your body at all times. You should avoid wearing bulky clothing that prevents it from doing so. Pull the belt periodically to re-tension it across your shoulder. In the event of a frontal impact, a loose lap belt could slide over your hips, leading to abdominal injury. In addition, the safety belt's restraint effectiveness is reduced if the belt is worn loosely.

Expectant mothers should always wear their safety belts, taking care to posi-

tion the lap belt against the lower hips, where it will not exert pressure against the abdominal area. ◀

For child restraint system installation, refer to page 59.

 If the safety belt system has been subjected to the stresses involved in an accident or otherwise damaged, have the entire safety belt mechanism replaced by your BMW center, including the safety belt tensioner. In addition, have your BMW center inspect the safety belt anchors. If a child restraint system was in the vehicle during an accident, consult the manufacturer's instructions regarding replacement. ◀

### **Child restraint systems\***

 Never install a rear-facing child restraint system on the front passenger seat. If you do so, the child could be injured when the airbag is triggered.

Children should always ride in the rear and the restraint systems should be secured with the outer belts. The center seat belt should only be used when it is necessary to secure three child restraint systems. Do not modify the child restraint system in any way. If you do so, it will not provide your child with maximum protection. ◀

# Airbags

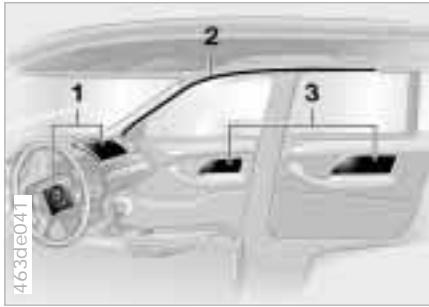

- 1 Front airbags for driver and passenger
- 2 Side impact Head Protection System for driver and passenger (front)
- 3 Side airbags for driver and passenger (front and rear\*)

## Protective effect

The front airbags supplement the three-point safety belts by providing additional protection for the front-seat occupants, in the event of a severe frontal collision in which the protection afforded by the belts alone may no longer be sufficient. The Head Protection System and side airbags help provide protection in the event of a collision from the side. Each of the side airbags is designed to help support the occupant's upper body.

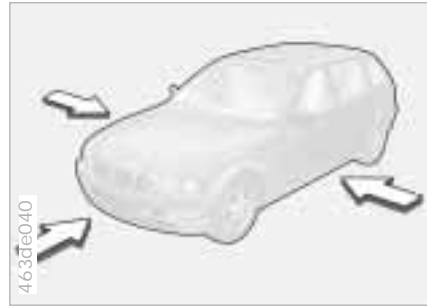

▶ The side airbags in the rear passenger area\* of your vehicle may already have been deactivated either at the time of manufacture or by a BMW center. You may have them activated if you desire to do so. Please contact your BMW center for additional information. ◀

The illustration depicts schematically the primary directions of vehicle impact that initiate airbag deployment.

▶ The airbags will not be triggered in the event of a minor accident, a vehicle roll-over, or collisions from the rear. ◀

## Operational status



The indicator lamp in the instrument cluster displays the operational status of the airbag system from ignition key position 1 and up.

System operational:

▶ The indicator lamp comes on briefly then goes out.

System malfunction:

- ▶ The indicator lamp fails to come on.
- ▶ The indicator lamp comes on briefly before going out and then lighting up again.

If there is a system malfunction, there is a risk that the airbags will not be triggered within their normal response range, even if the level of impact would normally have triggered them.

Have your BMW center inspect and repair the system immediately.



▶ The airbag indicator lamp also comes on if the safety belt tensioners have been triggered. ◀

**Sitting correctly with airbags**

 For your safety, comply with the following instructions for the airbags. If you do not, the airbags may not be able to provide their maximum protection. All passengers in the vehicle should be aware of and comply with this information:

The airbags are supplemental restraint devices designed to provide extra protection; they are not a substitute for safety belts. Wear your safety belt at all times. The airbags will not be triggered in the event of a minor accident, a vehicle roll-over, or collisions from the rear. In these instances, the safety belt provides optimal protection.

Airbags are located under cover panels in the steering wheel, in the dashboard, in the side trim panels in the front and rear\*, in the roof panels, and in the sides of the inside roof lining.

Adjust your seat to a position that provides maximum distance between you and the steering wheel, the instrument panel and the door while still allowing comfortable and safe access to all vehicle controls.

To avoid sustaining hand and arm injuries, always grasp the steering wheel on the rim with the hands at the 9 and 3 o'clock positions. Do not place your hands on the center pad.

Never allow any objects to obstruct the area between the airbag and an occupant.

Do not use the cover panel above the passenger-side airbag as a storage area.

Do not apply adhesive materials to the cover panels of the airbags, cover them or modify them in any other way.

Do not install a rear-facing child restraint system in the front passenger seat of this car.

Children under 13 years of age and children less than 5 feet (150 cm) tall should only ride in the rear seat. Infants or small children should never be held on the lap of a passenger.

If your car is equipped with side airbags in the rear passenger area\*, be sure that child restraints are mounted correctly and provided with the greatest-possible distance between the airbags in the side trim panels. Do not allow children to lean out of the child's seat in the direction of the side trim panels. If they do so, serious injuries can occur if the airbag is triggered. ◀



At all times, occupants should sit upright and be properly restrained (infants and small children in appropriate child restraint systems; larger children and adults using the safety belts). Never let an occupant's head rest near or on a side airbag, because as the inflating airbag could cause a serious or fatal injury. Please note that the word "Airbag" imprinted on the door trim panel indicates the airbag's location.

Accident research shows that the safest place for children in an automobile is in the rear seat. However, a child sitting in the rear seat and not properly restrained may place his or her head on or near the airbag, if so equipped. For example, a child – even though belted – may fall asleep with his or her head against the side airbag. It may be difficult for a driver to ensure that children in the rear seat will remain properly positioned at all times and not place their heads on or near the side airbag. Therefore, we recommend that the rear seat side airbags, if so equipped, be deactivated if children will travel in the rear seat.

The rear seat side airbags may already have been deactivated, either at the time of manufacture or by a BMW



## Airbags

center. Labels in the rear door opening should indicate the status of your rear seat side airbags. If you are uncertain of their status, or wish to have the airbags activated or deactivated, please contact your BMW center. ◀

Even when all these guidelines are observed, there is still a small residual risk of injuries to the face, hands and arms occurring from airbag deployment in isolated instances. The ignition and inflation noise may induce a mild temporary hearing loss in sensitive individuals.

For additional information concerning the airbag system, refer to pages [147](#) and [172](#).



This is the right way for a child to sit in a child restraint when rear side airbags (arrow) are provided.



This is the right way for a larger child to sit wearing the safety belt when rear side airbags (arrow) are provided.

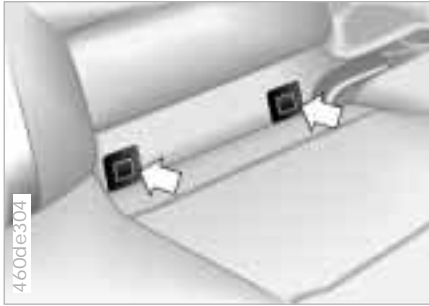

### **LATCH attachment of the child seat**

The illustration shows the right rear seat.

The mounts for the LATCH attachment of the child seat are located behind the plastic covers (arrows), and are covered again once the LATCH attachment of the child seat has been removed.



To mount the LATCH attachment of the child seat, please follow the manufacturer's operating and safety precautions. ◀



### **Child-safety locks**

On a rear door, push the safety lever downward:

The door can now be opened from the outside only.

## Transporting children safely

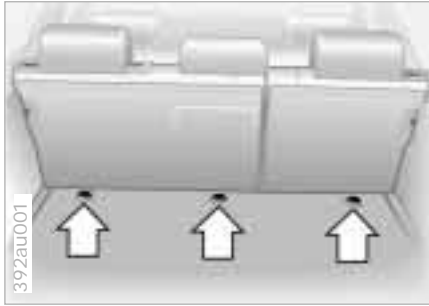

Commercially available child seats complying with the legal standard are designed to be secured with a lap belt or with the lap belt portion of a combination lap/shoulder belt. Improperly or inadequately installed restraint systems can increase the risk of injury to children. Always read and follow the instructions that come with the system.

If you use a child restraint system with a tether strap, three additional tether anchorage points (refer to the arrows in the illustration) have been provided. Depending on the location selected for seating in the rear passenger area, attach the tether strap to the corresponding anchorage point to secure the child restraint system. Remove the cover first on the middle location.

If the respective seating position is fitted with a headrest, lift the headrest and pass the tether strap between the headrest and the seat back.

Adjust the tether strap according to the child restraint manufacturer's instructions.



Before installing any child restraint device or child seat, please read the following:

Never install a rear-facing child restraint system in the front passenger seat of this vehicle.

Your vehicle is equipped with an airbag supplemental restraint system for the front passenger. Because the backrest on any rear-facing child restraint system (of the kind designed for infants under 1 year and 20 lbs./9 kg) would be within the airbag's deployment range, you should never mount such a device in the front passenger seat, since the impact of the airbag against the child restraint's backrest could lead to serious or fatal injuries.

If it is necessary for a child (not an infant) to ride in the front seat, certain precautions should be taken. First, move the passenger seat as far away from the dashboard as possible. This important precaution is intended to

maximize the distance between the airbag and the child. Older children should be tightly secured with the safety belt. Younger children should be secured in an appropriate forward-facing child restraint system that has first been properly secured with a safety belt.

Never install a rear-facing child restraint system in the front passenger seat. We strongly urge you to carefully read and comply with the instructions for installation and use provided by the child restraint's manufacturer whenever you use such a device.

Be sure that all occupants (of all ages) remain properly and securely restrained at all times. ◀

All rear seating positions in your vehicle meet the recommendations of SAE J1819, an industry recommended practice for securing child restraint systems in motor vehicles.

## 60 Transporting children safely



### **Lock the safety belt**

Extract the entire length of the belt from the inertia reel mechanism. Allow the reel to retract the belt somewhat and engage the buckle, then tighten the belt against the child restraint system. The retraction mechanism is now locked. The belt cannot be extracted farther. Always comply with the installation instructions provided by the manufacturer of the child restraint system.

### **Unlock the safety belt**

Release the safety belt, remove the child's seat and retract the safety belt to its end position on the belt retractor.

### **Child seat security**

All of the rear belt retractors and the front passenger's safety belt can be locked for mounting and securing child restraint systems.

Information pertaining to this is located in the immediate vicinity of the buckle latch of each safety belt.



## 0 Steering lock engaged

The key can be inserted or removed in this position only.

After removing the key, turn the steering wheel slightly to the left or right until the lock engages.

If the key has been left in the ignition, an acoustic signal will sound after the door has been opened.

 Vehicles with automatic transmission:

Do not move the selector lever from the "Park" position until the engine is running (ignition key at position 2).

In order to turn the key to position 0 or to remove it, first move the selector lever to the position "Park" (Interlock). ◀

## 1 Steering lock disengaged

Turning the steering wheel slightly to the right or left often makes it easier to turn the key from 0 to 1.

Individual electrical devices are ready for operation.

## 2 Ignition on

All electrical equipment and accessories are available for use.

## 3 Starting the engine

 Vehicles with manual transmission:

Depress the clutch when starting the vehicle. A lockout prevents the engine from starting if the clutch is not depressed. ◀

## Before starting

- ▷ Engage the parking brake.
- ▷ Put the manual-shift gear lever in idle or in P for an automatic transmission.
- ▷ Depress the clutch pedal.

 Do not run the engine in enclosed areas. The exhaust gases contain carbon monoxide, an odorless and colorless, but highly toxic gas.

Breathing the exhaust gases poses an extreme health risk, and can lead to unconsciousness and death.

Never leave the vehicle unattended with the engine running. An unattended vehicle with a running engine represents a potential safety hazard. ◀

Do not press the accelerator pedal when starting the engine.

 Do not actuate the starter for too short a time, but do not keep turning it for more than approx. 20 seconds. Release the ignition key immediately when the engine starts. Do not allow the engine to warm up by leaving it running while the vehicle remains stationary. Instead, drive off immediately at a moderate engine speed. ◀

## 62 Starting the engine

If the engine does not start on the first attempt (if it is very hot or cold, for instance):

- ▷ Press the accelerator pedal halfway down while engaging the starter.

Cold start at very low temperatures approx. +5 °F (-15 °C) at high altitude over 3,300 ft (1000 m):

- ▷ On the first start attempt, engage the starter for a longer period (approx. 10 seconds).
- ▷ Press the accelerator pedal halfway down while engaging the starter.

Engine idle speed is controlled by the engine computer system. Increased speeds at start-up are normal and should decrease as the engine warms up. If engine speed does not decrease, service is required.

To prevent the battery from discharging, always switch off electrical devices which are not in use and the ignition when the vehicle is not being driven.

## Switching off the engine

Turn the ignition key to position 1 or 0.



Never remove the ignition key while the vehicle is still moving. If you did so, the steering lock would engage when the steering wheel is turned.

When you leave the vehicle, always remove the ignition key and engage the steering lock.

Vehicles with manual transmission:

Always engage the parking brake when parking on slopes and inclined surfaces, since placing the lever in 1st gear or reverse may not provide adequate resistance to rolling.

Vehicles with automatic transmission:

Place the selector lever in "Park." ◀

## Parking brake



### To engage

The parking brake is designed primarily to prevent the vehicle from rolling when it is parked. It acts on the rear wheels.

The lock engages automatically when you lift the lever, and the indicator lamp in the instrument panel comes on when the ignition key is in position 2. Refer to page 21.

### To release

Pull up slightly on the lever, press the button (arrow) and lower the lever.

**⚠** If, in exceptional circumstances, it should be necessary to apply the parking brake while the vehicle is in motion, do not pull the lever with excessive pressure. Keep your thumb pressed against the release button while carefully pulling the lever up to apply moderate pressure. Excessive pressure can lead to over-braking and loss of traction (fishtailing) at the rear axle.

The brake lamps do not come on when the parking brake is applied.

Vehicles with manual transmission:

Always apply the parking brake when parking on slopes and inclined surfaces, since placing the lever in 1st gear or reverse may not provide adequate resistance to rolling.

Vehicles with automatic transmission:

Place the selector lever in "Park." ◀

To avoid corrosion and one-sided braking, apply the parking brake lightly from time to time when coasting to a standstill (at a traffic signal, for instance), provided that it is safe to do so.

## 64 Manual transmission



Completely depress the clutch pedal each time you shift, pressing the manual-shift gear lever into its respective end position.

Also depress the clutch when starting the vehicle, as otherwise lockout will prevent the engine from starting.

The shift lever's neutral plane (dot in the illustration) is located between 3rd and 4th gears.

When shifting from each gear into "Neutral," the shift lever returns automatically to this gear plane because of its spring loading.

### Reverse

Select "Reverse" only when the vehicle is stationary. Press the shift lever to the left to overcome the resistance.

As you do this, the backup lamps will turn on automatically when the ignition key is in position 2.



Do not hold the vehicle in place on slopes by slipping or "riding" the clutch. Use the parking brake instead. Otherwise, riding the clutch will cause heavy wear and tear to the clutch. ◀



You have the option of driving with a normal automatic transmission or switching to manual.

When you move the selector lever from the "D" position to the left into the M/S range, the performance-oriented shift programs of the automatic transmission are engaged. As soon as you tap the selector lever in the "+" or "-" direction, Steptronic changes the gear. The manual mode is engaged. Whenever you want to use the automatic mode again, move the selector lever to the right into position "D."

The automatic transmission with Steptronic is equipped with Adaptive Transmission Control (ATC). ATC reacts with precision to your individual driving style and the current driving conditions. It is for this reason that various shift programs are used.

For additional information concerning the ATC, please refer to the chapter describing "Advanced technology" on page 173.



## Selector lever positions

P R N D M/S + -

## Starting the engine

The engine can only be started in selector lever positions P ("Park") or N ("Neutral").

## Range selection

A detent prevents inadvertent shifts into some selector lever positions. To release the shift-lock mechanism, press the button on the front side of the selector handle (arrow).

 While the vehicle is stationary and before shifting out of "Park" or "Neutral," depress the footbrake, otherwise the selector lever will be blocked (shiftlock).

Hold the footbrake down until starting off. Otherwise the vehicle will "creep" when a drive position is engaged. ◀

 Before leaving the vehicle with the engine running, move the selector lever to the "Park" or "Neutral" position and apply the parking brake. The vehicle will move if this is not done. Do not leave the vehicle unattended with the engine running. An unattended vehicle with a running engine represents a potential safety hazard. ◀

## P Park

Select "Park" only when the vehicle is stationary. The transmission locks to prevent the rear wheels from turning.

## R Reverse

Select "Reverse" only when the vehicle is stationary.

## N Neutral

Select "Neutral" only if your journey is interrupted for a longer period.

### **D Drive (automatic shift program)**

This position is designed for driving under all normal operating conditions. All forward gears are available and the ATC is fully operational.

### **"Kickdown"**

You will get maximum vehicle performance in the "kickdown" mode.

To activate this mode, depress the accelerator pedal beyond the full-throttle position, at which a resistance point must be overcome.



### **M/S Manual mode and Sport Program**

Shifting from D into M/S activates the Sport Program. This is indicated by "SD" in the gear selection display. This position is recommended for a performance-oriented driving style.

With the first brief touch, the automatic transmission shifts from the Sport Program to the manual mode.

Whenever you tap the selector lever forward in the "+" direction, the transmission shifts up. Whenever the lever is moved back in the "-" direction, the transmission shifts down. M1 to M5 appear in the gear indicator.

Upshifts or downshifts will only be carried out by the ATC at appropriate engine speeds and road speeds. If the engine speed is too high, for instance, a downshift will not be executed. The gear selected will appear briefly in the instrument cluster followed by the current gear.

 To accelerate quickly in the manual mode (to pass another vehicle), shift down manually or employ the "kickdown" mode. ◀

Shifting from M/S to the selector lever positions P, R and N is possible only by going through D.

In the following situations, the Steptronic "thinks" for you in the manual mode:

- ▷ In order to prevent engine over-speeding, the transmission shifts automatically to the next higher gear shortly before the engine speed cutoff point.
- ▷ At low speeds, the transmission shifts down automatically – you do not have to act.
- ▷ In the "kickdown" mode, the transmission shifts down to the lowest gear possible, depending on the engine speed.
- ▷ Depending on the situation – when driving in adverse winter conditions, for example – you may also start out in 2nd or 3rd gear.



## Available displays

P R N D SD M1 M2 M3 M4 M5

## Electronic transmission control module



If the indicator lamp comes on, there is a malfunction in the transmission system.

Bring the vehicle to a stop, select transmission position "P," set the parking brake and turn the engine off (ignition key to position 0).

Wait a few seconds, then start the engine. If the indicator lamp goes out after a few seconds, normal transmission performance has been restored. Drive off normally.

If the indicator lamp does not go out, all selector lever positions can still be selected, however in the forward positions the vehicle has limited performance, as it drives only in 3<sup>rd</sup> and 4<sup>th</sup> gear.

If this happens, avoid extreme engine loads and consult the nearest BMW center.



Do not perform service operations in the engine compartment with a drive position engaged. If you do so, the vehicle could move. ◀

For towing, tow-starting or jump-starting the vehicle, refer to the information beginning on page [167](#).

## 68 Turn signal indicator/Headlamp flasher



### To signal briefly

Press the lever up to but not beyond the detent. It then returns to the center position when released.

- 1 High beams  
(blue indicator lamp)
- 2 Headlamp flasher  
(blue indicator lamp)
- 3 Turn signal indicator (green indicator lamp accompanied by periodic clicking sound from the relay)

If the indicator lamp and the clicking from the relay are both faster than normal, one of the turn indicators has failed.

## Washer/Wiper system



- 0 Wipers retracted
- 1 Intermittent mode or rain sensor
- 2 Normal wipe
- 3 Fast wipe
- 4 Brief wipe
- 5 Cleaning windshield
- 6 Rotary dial for control of the wipe interval or the sensitivity of the rain sensor

### Rear window wiper

- 7 Intermittent mode
- 8 Cleaning rear window

# Washer/Wiper system



## 1 Intermittent mode or rain sensor\*

Intermittent mode:

You can use rotary dial 6 to select from four wipe intervals.

In addition, the wipe interval automatically adapts to variations in road speed.

Rain sensor:

The rain sensor is positioned on the windshield, directly ahead of the interior rearview mirror. When the rain sensor is activated, the windshield wiper is controlled automatically, depending on the degree of wetness of the windshield (in both snow and rain). You do not have to be concerned with switching the windshield wiper on or off or adjusting the wipe interval between intermittent and full wipe. Instead, you

can concentrate fully on the traffic conditions. This is especially important under adverse weather conditions.

To activate the rain sensor:

From ignition key position 1 and up, move the lever to position 1. The wipers travel once across the windshield, regardless of the weather.

You can leave the lever permanently in position 1. It is then only necessary to activate the rain sensor from ignition key position 1 and up. To do this,

- ▷ turn rotary dial 6 briefly or
- ▷ use cleaning windshield 5.

To modify the sensitivity of the rain sensor:

Turn rotary dial 6.

Deactivating the rain sensor:

Put lever in position 0.



Turn the rain sensor off when passing through an automatic car wash. Failure to do so could result in damage caused by undesired wiper activation. ◀

## 2 Normal wiper speed

When the vehicle is stationary, the wipers switch automatically to intermittent wipe (not on vehicles with rain sensor).

## 3 Fast wiper speed

When the vehicle is stationary, the wipers operate at normal speed (not on vehicles with rain sensor).

## 5 Cleaning windshield

The system sprays washer fluid against the windshield and activates the wipers for a brief period.

If you only pull the lever briefly, the system sprays washer fluid onto the windshield without activating the wipers.

### 7 Rear window wiper

Rear window wiper in intermittent mode. When reverse gear is engaged, continuous operation is switched on automatically

You can also program the interval:

- ▷ Switch briefly from position 0 to position 7.
- ▷ The time until reactivation (from position 0 to 7) is the programmed interval (max. 30 seconds).

### 8 Cleaning rear window

Washer fluid sprayed on the rear window.

Refer to page [152](#) for changing the wiper blades.

### Cleaning headlamps\*

If the headlamps are on, they will also be cleaned every fifth time you activate cleaning windshield.



Do not use the washers if there is any danger that the fluid will freeze on the windshield. If you do so, your vision could be obscured. Use an anti-freeze agent. Refer to page [134](#). Do not use the washers when the reservoir is empty. If you do so, the washer pump could be damaged. ◀

### Windshield washer jets

The windshield washer jets are heated automatically\* when the ignition key is in position 2.

## Rear window defroster



The illustration shows the button set-up for vehicles equipped with automatic climate control. For other layouts, refer to page [90](#).

### To activate

- ▷ Press the button once: as long as the indicator lamp remains on, the rear window defroster continues at high output (rapid thaw).
- ▷ Press button twice: the rear window defroster operates continuously.

### To deactivate

If the indicator lamp is still on, press the button.



The vehicle can store and automatically maintain any desired vehicle speed above approx. 20 mph (30 km/h) that you input.

 Do not use the cruise control on winding roads, when high traffic density prevents driving at a constant speed, when the road surface is slick (snow, rain, ice), or when the road surface is loose (rocks, sand). ◀

## To activate the system

From ignition key position 2:  
Press button 1. The indicator lamp in the instrument cluster comes on. You can now use the cruise control.

## To store and maintain speed or to accelerate

Press button 2 briefly:  
The system registers and maintains the current vehicle speed. Every time you briefly touch the button, the speed increases by 0.6 mph (1 km/h).

Press and hold button 2:  
The vehicle accelerates without pressure on the accelerator pedal. When you release the button, the system registers and maintains the current speed.

 If, on a downhill gradient, the engine braking effect is not sufficient, the controlled speed can be exceeded. Speed can drop on uphill grades if the engine output is insufficient. ◀

## To decelerate

Press button 3 briefly:  
If you are already driving with active cruise control, the speed is decreased by approx. 0.6 mph (1 km/h) every time you briefly touch the lever.

Press and hold button 3:  
With the cruise control active, the system automatically reduces the throttle opening to slow the vehicle. When you release the button, the system registers and maintains the current speed.

### **To cancel the cruise control**

When the system is activated, press button 1. The indicator lamp stays on. You can use the cruise control again as required.

In addition, cruise control is canceled automatically:

- ▷ When braking.
- ▷ If the clutch is depressed or the automatic transmission selector lever is moved from "Drive" to "Neutral".
- ▷ If you exceed or fall below the programmed speed for an extended period (by depressing the accelerator, for example).

### **To resume the stored setting**

Press button 4:

The vehicle accelerates to and maintains the last speed stored. When you turn the ignition key to position 0, the stored speed is deleted from the system's memory and the system is deactivated.

### **To deactivate the system**

When the cruise control has been canceled, press button 1 again. The indicator lamp goes out and the stored speed is deleted.





## 1 Odometer

You can activate the displays shown in the illustration with the ignition key in position 0 by pressing the button in the instrument cluster (arrow).

## 2 Trip odometer

To reset the trip odometer to zero, press the button (arrow) with the ignition key in position 1 and up.



Avoid engine speeds in the red warning zone of the gauge.

To protect the engine, the engine-management system automatically interrupts the fuel supply in this range; the resulting effect resembles that associated with a sudden loss of power.



Indicates current fuel consumption in mpg (in liters per 100 km on Canadian vehicles). You can check your current driving style to see whether it is conducive to economy and minimum exhaust emissions.

When the vehicle is stationary, the display goes to "Maximum" (zero on Canadian models).



When you switch on the ignition, the indicator lamp lights up briefly as a function check.

Once the indicator lamp stays on continuously, there are still approx. 2 gallons (8 liters) of fuel left in the fuel tank.

For fuel tank capacity, refer to page 187.

If the tilt of the vehicle varies (extended driving in mountainous areas, for example), there may be slight fluctuations of the needle.



Please refuel early, since driving to the last drop of fuel can result in damage to the engine and/or catalytic converter. ◀



### Blue

The engine is still cold. Drive at moderate engine and vehicle speeds.

### Red

When you switch on the ignition, the warning lamp comes on briefly as a function check.

If the lamp comes on while operating the vehicle, the engine has overheated. Switch the engine off immediately and allow it to cool down.

### Between the blue and red zones

Normal operating range. It is not unusual for the needle to rise as far as the edge of the red zone in response to high outside temperatures or severe operating conditions. Checking coolant level: refer to page 137.



### Remaining distance for service

The displays shown in the illustration appear for a few seconds when the ignition key is in position 1 or after the engine is started.

The next service due appears with the message OIL SERVICE or INSPECTION, together with the remaining distance before scheduled service.

The computer bases its calculations of the remaining distance on the rate of fuel consumption in the period immediately preceding your data request.

A flashing display and a "-" in front of the number indicate that service is past due by the number of kilometers/miles displayed. Please contact your BMW center for an appointment.

## Check Control

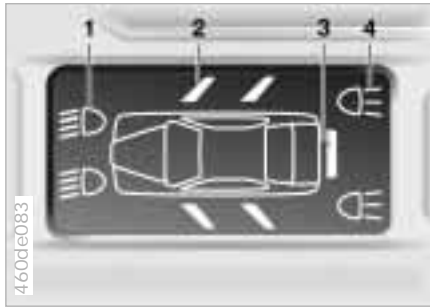

### Graphic display

The following information and/or conditions are indicated using symbols, starting with the ignition key position 2, until the condition has been corrected:

- 1 Inspect the low-beam and high-beam headlamps, as well as the side lamps
- 2 Door open
- 3 Tailgate open
- 4 Check brake and brake lamps

When you open the driver's door after stopping with the lights still on, a warning signal sounds for LIGHTS ON.

## Clock

If you wish to have a permanent time display, you can make this adjustment in the radio display (refer to the Radio Owner's Manual).

You can adjust the clock and the time display in the car radio as follows.



### Adjustments

From ignition key position 1

To set ahead: turn the right button to the right.

To set back: turn the right button to the left.

The adjustment speed will increase the longer you continue to hold the button turned to the left.

To change the display mode: press the knob briefly.

Every time you press the knob, the clock display alternates between the 12-hour or 24-hour mode.

In ignition key position 0:

The time is displayed for a few seconds after you press the left button (refer to "Odometer" on page 73).

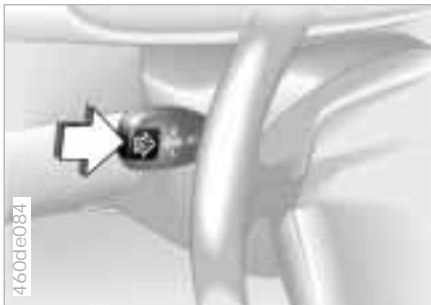

### Mode selection

In ignition key positions 1 and 2, you can call up information from the computer using the button in the turn signal lever. By pressing the button briefly in the direction of the steering column, you can call up a new function for display.

The displays appear in the following order:

Time, outside temperature, average fuel consumption, cruising range, average vehicle speed.

Starting with ignition key position 1, the last active setting is displayed.



### Outside temperature

You can change the units of measurement (°C/°F) for the outside temperature display by pressing the right-hand reset button in the instrument cluster when the temperature display is active.

### Ice warning

If the outside temperature drops to approx. +37.5 °F (+3 °C), the computer automatically switches to the outside temperature display. In addition, a signal sounds as a warning and the display flashes for a brief period.

The warning is repeated whenever the temperature climbs to at least +43 °F (+6 °C) following the last warning, and then drops back to +37.5 °F (+3 °C).



The ice warning does not alter the fact that surface ice can form at temperatures above +37.5 °F (+3 °C), on bridges or shaded road surfaces, for instance. ◀



### Average fuel consumption

If you continue to hold the button on the turn signal lever, the average fuel consumption last displayed is recalculated from that point.



### Range

The computer bases its calculations of the cruising range on the previous driving style and the amount of fuel remaining.



### Average speed

If you continue to hold the button on the turn signal lever, the average speed last displayed is recalculated from that point.

Any time spent when the vehicle is stationary and the engine is shut off is ignored for the calculation.

### **The concept**

The PDC assists you when you are parking. A signal warns you of the real distance to an obstacle. To do this, four ultrasonic sensors in the rear bumper measure the distance to the nearest object. The range for the sensors at the two rear corners ends approx. 2 ft (60 cm) from the bumper. The range for the two center sensors is approx. 4.9 ft (1.50 meters) wide.

The system starts to operate automatically about one second after you select "Reverse" with the ignition key in position 2. PDC is deactivated when you shift back out of reverse.

### **Acoustical signals**

The distance to the nearest object is indicated by a tone sounding at various intervals. As the distance between vehicle and object decreases, the intervals between the tones become shorter. If the distance between the vehicle and a detected object is less than 1ft (30 cm), then a continuous tone will go off.

The warning signal is canceled after approx. three seconds if the distance to the obstacle remains constant during this time (if you are moving parallel to a wall, for instance).

System malfunctions will be indicated by a continuous high-pitched tone when the system is activated the first time. Please refer the problem to your BMW center.



The PDC does not remove the driver's personal responsibility for evaluating the distance between the vehicle and any obstacles. Even when sensors are involved, there is a blind spot in which objects cannot be detected. This applies especially in those cases where the system approaches the physical limits of ultrasonic measurement, as occurs with tow bars and trailer couplings, and in the vicinity of thin and painted objects. Certain sources of sound, such as a loud radio, could drown the PDC signal tone. ◀



Keep the sensors clean and free of ice or snow in order to ensure that they continue to operate effectively. Do not apply high-pressure spray to the sensors for a prolonged period of time. Maintain a distance of more than 4 in (10 cm). ◀

## The concept

This system enhances driving stability and traction, especially when you are just starting off, accelerating or in curves.

ASC+T recognizes the danger present in traction loss and will increase driving stability and traction by reducing the engine's output, and if necessary, by applying the brakes to the rear wheels.

ASC+T is available as soon as the engine starts up.

## Indicator lamp



The indicator lamp in the instrument cluster goes out shortly after you switch on the ignition.

Refer to pages [21](#) and [22](#).

Indicator lamp flashes:  
ASC+T controls the drive and braking forces.

If the indicator lamp fails to go out after the engine is started, or if it comes on during normal driving and stays on:

There is a system malfunction or the system was deactivated with the button. Consequently, interventions to increase driving stability (as described in the preceding column) are not available. You can still drive the vehicle perfectly well without ASC+T.

Please consult your BMW center in the event of a fault, refer to pages [21](#) and [22](#).



## Deactivate the ASC+T

Press the button; the indicator lamp comes on and stays on.

The illustration shows the arrangement of the buttons if the vehicle is fully equipped. This may vary, depending on the equipment actually installed.

In the following rare situations, it may be effective to deactivate the ASC+T for a brief period:

- ▷ When rocking the vehicle or starting off in deep snow or on loose surfaces.
- ▷ When driving with snow chains. Refer also to page [121](#).



To maintain vehicle stability, always drive with the ASC+T activated whenever possible. ◀

### **Reactivate the ASC+T**

Press the button again; the indicator lamp goes out.



The laws of physics cannot be repealed, even with ASC+T. It will always be the driver's responsibility to drive in a manner that matches road conditions. This is why you should not use the additional safety margin the system provides as an excuse to take risks. ◀

For additional informations concerning ASC+T, please refer to "Advanced Technology" on page [173](#).



## The concept

DSC helps maintain vehicle stability, even in critical driving situations.

The system optimizes vehicle stability during acceleration and when starting from a full stop, as well as optimizing traction. In addition, the system recognizes unstable vehicle conditions (understeering or oversteering, for example) and helps hold the vehicle on a sure course by intervening via the engine and by braking intervention at the individual wheels.

The DSC is operational every time you start the engine. DSC contains the functions of ADB and CBC, refer to page 117.

The ADB (Automatic Differential Braking) copies the function of conventional differential and transverse lock through brake intervention, and increases traction whenever conditions merit, e.g. when driving on snow-covered roads.

If the DSC is switched off the ADB will still be in ready mode.

## Indicator lamp



The indicator lamp in the instrument cluster goes out shortly after you switch on the ignition.

Refer to pages 21 and 22.

Indicator lamp flashes: DSC is active and governs the drive force and braking force.

The indicator lamp lights up continuously:

The DSC has been turned off via the switch; ADB is ready to use.

ADB intervention is not indicated.



The indicator lamp and the brake warning lamp lights up continuously:



The DSC, ADB and DBC have been switched off via the button or are defective.



Indicator and warning lamps for Canadian models.



You can continue to drive the vehicle normally, but without DSC. Please consult your BMW center in the event of a malfunction, refer to pages 21 and 22.



## Deactivate DSC/activate ADB

Press the DSC button briefly, the indicator lamp lights up continuously.

The DSC has been switched off; ADB is operational.

In the following exceptional circumstances, it may be effective to deactivate the ADB for a short period:

- ▷ When rocking the vehicle or starting off in deep snow or on loose surfaces.
- ▷ When driving on snow-covered grades, in deep snow, or on a snow-covered surface that has been packed down from being driven on.
- ▷ When driving with snow chains. Refer also to page 121.

The gain in traction is achieved by a reduction in stabilizing intervention.

### **Deactivate DSC and ADB**

Hold the DSC switch down for at least 3 seconds. The indicator and the yellow brake warning lamps will remain on the entire time.

In this case, no interventions to increase stability and traction for engine and brakes are carried out.



To maintain vehicle stability, always drive with the DSC on whenever possible. ◀

### **Reactivate DSC and ADB**

Press the button again; the indicator lamp or the indicator lamps will go out.



The laws of physics cannot be repealed, even with DSC. It will always be the driver's responsibility to drive in a manner that matches road conditions. We therefore urge you to avoid using the additional safety margin of the system as an excuse for taking risks.

Whenever the ADB is activated, the DSC is switched off and will not perform any stabilizing intervention. Do not make any modifications to the DSC system. Allow only authorized technicians to perform service procedures on the DSC. ◀

For additional information concerning DSC, please refer to the chapter "Advanced technology" on page [173](#).

## The concept

DSC maintains vehicle stability, even in critical driving situations.

The system enhances vehicle stability during acceleration and when starting up from a full stop, and optimizes traction as well. In addition, it recognizes unstable vehicle conditions, such as understeering or oversteering, and, as far as is possible within the laws of physics, helps keep the vehicle on a steady course by reducing the engine output and brake applications to the individual wheels.

The DSC is operational every time you start the engine. DSC contains ADB-X und DBC, refer to page [118](#).

The ADB-X (Automatic Differential Braking) replaces the function of conventional differential and transverse lock through brake intervention, and increases traction whenever conditions merit, e.g. when driving on snow-covered streets.

## Indicator lamp



The indicator lamp on the instrument cluster will go out shortly after the ignition has been started. Refer to pages [21](#), [22](#).

If the indicator lamp flashes: DSC controls the drive and braking forces.

The indicator lamp stays lit: DSC is switched off via the switch; ADB-X is operational. ADB-X intervention not indicated.



If the indicator lamp does not go out after repeatedly pressing the DSC switch, then the DSC and the ADB-X are defective, and the intervention described to the right is then no longer available. ◀

The vehicle will remain completely operational, however, without DSC. In the event of a fault, please see your BMW center. Refer to pages [21](#), [22](#).



## Deactivate the DSC

Press the DSC button; the indicator lamp comes on and stays on.

The DSC has been switched off and the ADB-X is designed for maximum output.

In the following exceptional circumstances, it may be effective to deactivate the DSC for a short period:

- ▷ When rocking the vehicle or starting off in deep snow or on loose surfaces.
- ▷ When driving with snow chains. Refer also to page [121](#).



To maintain vehicle stability, always drive with the DSC on whenever possible. ◀

### **Reactivate the DSC**

Press the button again; the indicator lamp goes out.



The laws of physics cannot be repealed, even with DSC. It will always be the driver's responsibility to drive in a manner that matches road conditions. We therefore urge you to avoid using the additional safety margin of the system as an excuse for taking risks.

Whenever the DSC has been switched off, it will not perform any stabilizing intervention.

Do not make any changes to the DSC. Allow only authorized technicians to perform service procedures on the DSC. ◀

For additional information concerning DSC, please refer to "Advanced technology" on page [171](#).

## Tire Pressure Control (RDC)\*

### The concept

The RDC monitors the tire pressures at all four wheels, even when the vehicle is moving. The system provides an alert whenever the inflation pressure drops significantly below the specified pressure in one or more tires.

In order for the RDC system to "learn" the correct tire inflation pressure, first check the tire inflation pressure in all tires. Then compare these pressures with the tire inflation pressure chart (page 29) and adjust if necessary. Then activate the system.



This indicator lamp in the instrument cluster informs you whenever the tire pressure is not normal.



### Activate the system

Depending on the type of equipment, the switch either has the letters RDC on it or the RDC-symbol.

- 1 Turn the ignition key to position 2 (do not start the engine).
- 2 Press the switch long enough for the indicator lamp in the instrument cluster to light up yellow for a few seconds.
- 3 After a few minutes driving time, the RDC sets the current inflation pressure in the tires as the target values to be monitored.

You will only have to repeat this procedure following a correction of the tire inflation pressure. Otherwise, the RDC functions automatically when the ignition key is in position 2, and thus operates whenever the vehicle is driven.

### Loss of tire pressure

If the inflation pressure has dropped significantly over a long period of time (which is normal for any tire), the indicator lamp will come on with a yellow lamp.

This alerts you that you should have the tires inflated to the specified pressures as soon as possible.



If you are prompted to check the tire pressure shortly after a correction has been made, this indicates that the corrected values were not accurate. Please check the inflation pressure again and make corrections according to the inflation pressure table. Then activate the system once again. ◀

### **Flat tire**

If there is a tire failure with loss of pressure, the indicator lamp comes on with a red lamp. In addition, an acoustic signal goes off.

If this occurs, reduce vehicle speed immediately and stop the vehicle in a safe location. Avoid hard brake applications. Do not oversteer. Replace the wheel and flat tire.

 The space-saver spare tire is provided for temporary use only in the event of a tire failure. It does not have RDC electronics and is not monitored. A full-size spare tire that has the same dimensions as the tires already mounted on the vehicle is equipped with the necessary RDC electronics, and will also be monitored once the tires have been mounted and the system activated. ◀



The RDC cannot alert you to severe and sudden tire damage caused by external factors. ◀



Have the tires changed by your BMW center. Your BMW center has been trained to work with the RDC system and is equipped with the necessary special tools. ◀

### **System interference**

The RDC may encounter interference from outside equipment or devices which use the same radio frequency.

The indicator lamp will come on with a yellow lamp during the malfunction.

The indicator lamp also comes on

- ▷ in the event of a system fault
- ▷ if a wheel is mounted without the RDC electronics
- ▷ if, in addition to the spare tire, additional wheels with RDC electronics are on board.

Please contact your BMW center for additional information.

## Side lamps/Low beams



### Side lamps



With the switch in this position, the front, rear and side vehicle lighting comes on. As an additional feature, you can illuminate your vehicle on either side for parking, refer to page 88.

### Low beam headlamps



When you switch the ignition off with the low beam headlamps on, only the parking lamps will remain on.



**"Follow-Me-Home" lamps:**  
If you actuate the headlamp flasher after you have turned the vehicle off, the low beams will come on for a brief period. You may also have this function deactivated if you wish. ◀

### "LAMPS ON" warning

When you open the driver's door after turning the ignition key to position 0, an acoustic signal will go off for a few seconds to remind you when the headlamps have not been switched off.

### Daytime running lamps\*

If you desire, the lamp switch can be left in the second position:

When the ignition is switched off, the external lighting is also switched off.

## Instrument lighting



Turn the rotary dial to adjust the illumination intensity.

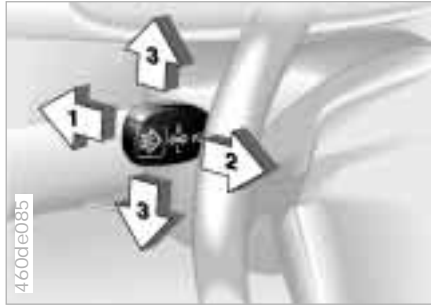

- 1 High beams  
(blue indicator lamp)
- 2 Headlamp flasher  
(blue indicator lamp)
- 3 Parking lamp

### **Parking lamps, left or right**

As an additional feature, you can illuminate your vehicle on either side for parking, if you wish to do so:

With the ignition key in position 0, engage the lever in the appropriate turn-signal position.



### **Fog lamps**



A green indicator lamp comes on in the instrument cluster to indicate that the front fog lamps are on.



The illustration provides an example of the interior lamps when equipped with reading lamps.

The interior lamps operate automatically.

### **To switch the interior lamps on and off manually**

Press the button briefly.

If you want the interior lamps to remain off all the time, press and hold the button for approx. 3 seconds.

To revert to normal operation, press the button briefly.

### **Footwell lamps\***

The footwell lamps operate in the same way as the interior lamps.



## Interior lamps



 In order to prevent draining the battery, all of the lamps in the vehicle are switched off automatically approx. 15 minutes after the ignition key is turned to position 0. ◀

### Reading lamps, front

The reading lamps can be switched on and off with the switch adjacent to each lamp.



### Reading lamps, rear

The reading lamps can be switched on and off with the switch adjacent to each lamp.

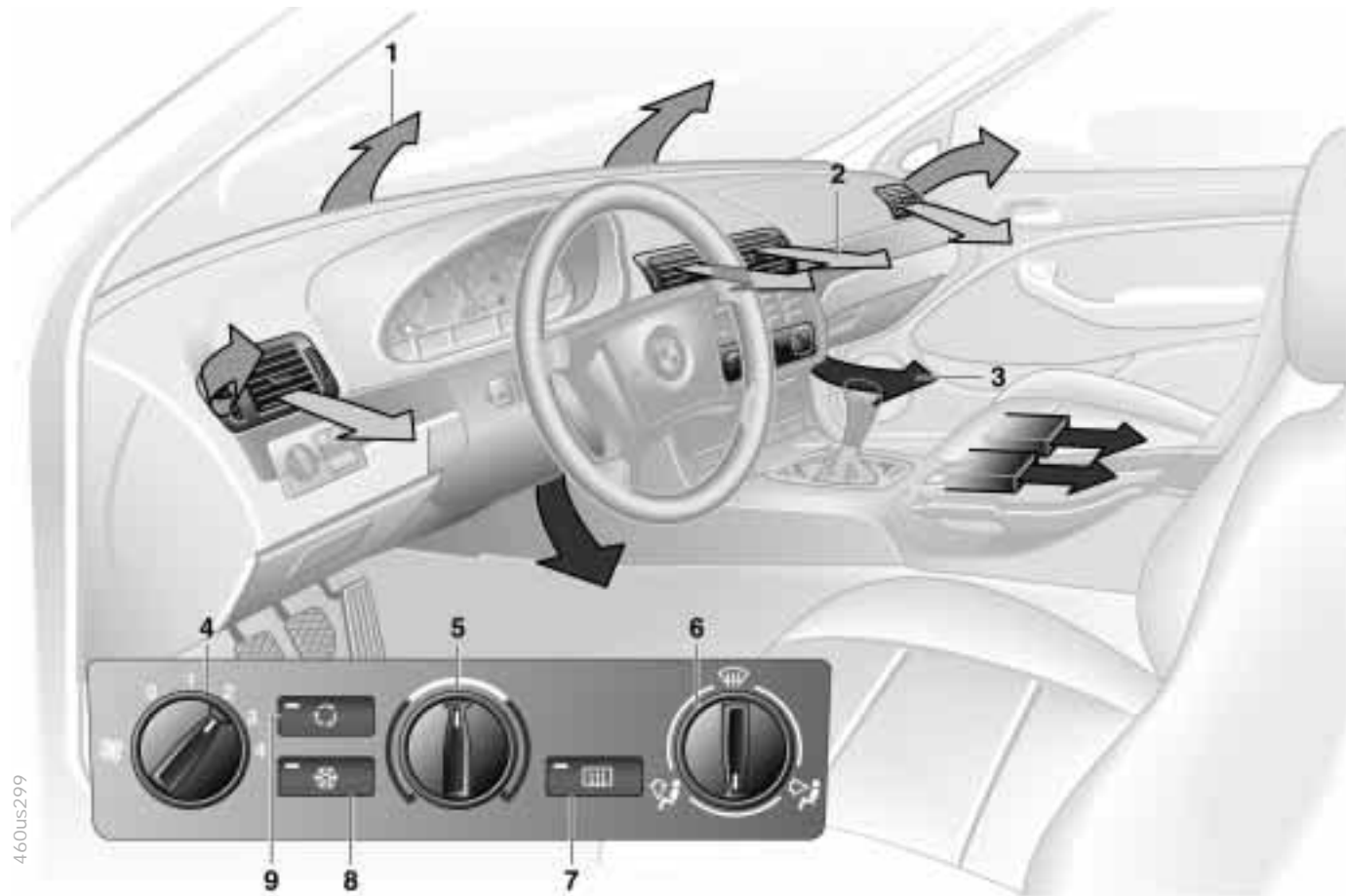
## 90 Air conditioner



# Air conditioner

- 1 Air onto the windshield and onto the side windows
- 2 Air flow for the upper body  
The side rotary dials allow you to open and close the air supply through an infinitely-variable range, while the levers change the airflow direction. The center rotary dial controls the temperature of the air as it flows out. Refer to page [92](#)
- 3 Ventilation for the front footwell  
There are corresponding air vents in the rear footwell as well
- 4 Air supply  
Heating and ventilation are available starting with position 1. Refer to page [92](#)
- 5 Temperature [92](#)
- 6 Air distribution toward
  - ▷ the windows 
  - ▷ the upper body 
  - ▷ the footwell 
 All intermediate settings are possible.  
Refer to page [92](#)
- 7 Rear window defroster [92](#)
- 8 Air conditioner [92](#)
- 9 Recirculated-air mode [92](#)





**Air supply**

You can select fan speeds from 1 to 4. The greater the air supply, the more effective the heating and ventilation are. In position 0, the fan and the heater are switched off. By using position 0, you can totally block the interior ventilation outlets by pressing the button for the recirculated-air mode.

**Temperature**

In order to increase the temperature of the passenger compartment, turn it to the right (red). Temperature regulation will keep the interior temperature you have selected constant.

**Air distribution**

You can direct air to flow onto the windows , toward the upper body  and into the footwell . You can also make all intermediate settings. In the  setting, there is a low flow of air onto the windows to keep them free of condensation. The "6 o'clock" setting is recommended as a normal setting (refer also to the illustration and overview on page 90).

**Rear window defroster**

When the rear window defroster is activated, the indicator lamp comes on. The rear window defroster switches off automatically. Refer to page 70.

**Air conditioner**

The air is cooled and dehumidified and – depending on the temperature setting – rewarmed when the air conditioner system is switched on.

Depending on the weather, the windshield may fog over briefly when the engine is started.

Use the button to switch the air conditioner off at outside temperatures below approx. 41 °F (+5 °C). This will help to prevent the windows from fogging up.

If the windows fog over after switching the air conditioner off, switch it back on.



Condensation forms in the air conditioner system during operation, which then exits under the vehicle. Traces of condensed water of this kind are thus normal. ◀

**Recirculated-air mode**

You can respond to unpleasant external odors by temporarily blocking the outside air. The system then recirculates the air already within the vehicle.



If the windows fog over in the recirculated air mode, switch the recirculated air off and increase the air supply as required. ◀

# Air conditioner

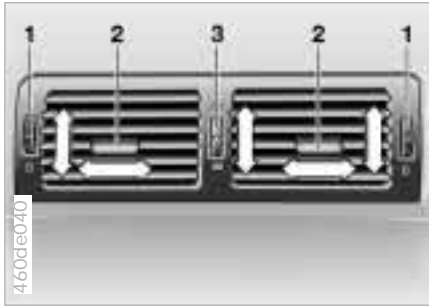

## Draft-free ventilation

You can adjust the blower controls for the upper body area to select the optimum airflow rates and directions for your personal requirements:

Use rotary dials 1 to open and close the air outlets through an infinitely-variable range. You can adjust the direction of the airflow with rotary dial 2.

Set the outlets so that the air flows past you and is not directed straight at you.

Rotary dial 3 allows you to control the temperature of the air flow from these outlets as desired.

## Microfilter

An activated-charcoal microfilter, which traps incoming dust and pollen, has been installed in your vehicle. Your BMW center will replace it during regularly scheduled maintenance. A substantial reduction in air supply indicates that the filter must be replaced before normal maintenance.

For additional details on the filter change, refer to page [165](#).



## Rapid ventilation

- 1 Set the fan speed control for the air flow rate to position 4.
- 2 Switch on the air conditioner.
- 3 Turn the rotary temperature control completely to the left (blue).
- 4 Rotary control for air distribution in position .
- 5 Open the air outlets for the upper body.



### **Rapid heating**

- 1 Set the fan speed control for the air flow rate to position 3.
- 2 Turn the rotary temperature control completely to the right (red).
- 3 Rotary control for air distribution in position .



### **Defrost windows and remove condensation**

- 1 Set the fan speed control for the air flow rate to position 4.
- 2 Turn the rotary temperature control completely to the right (red).
- 3 Rotary control for air distribution in position .
- 4 Switch on the rear window defroster to defrost the rear window.



### **Heating**

When the windows are free of ice and condensation, we recommend the following settings:

- 1 Set the fan speed control for the air flow rate to position 2.
- 2 Use the rotary temperature control to select an interior temperature which is comfortable for you.
- 3 Rotary control for air distribution in position .



## 96 Automatic climate control\*

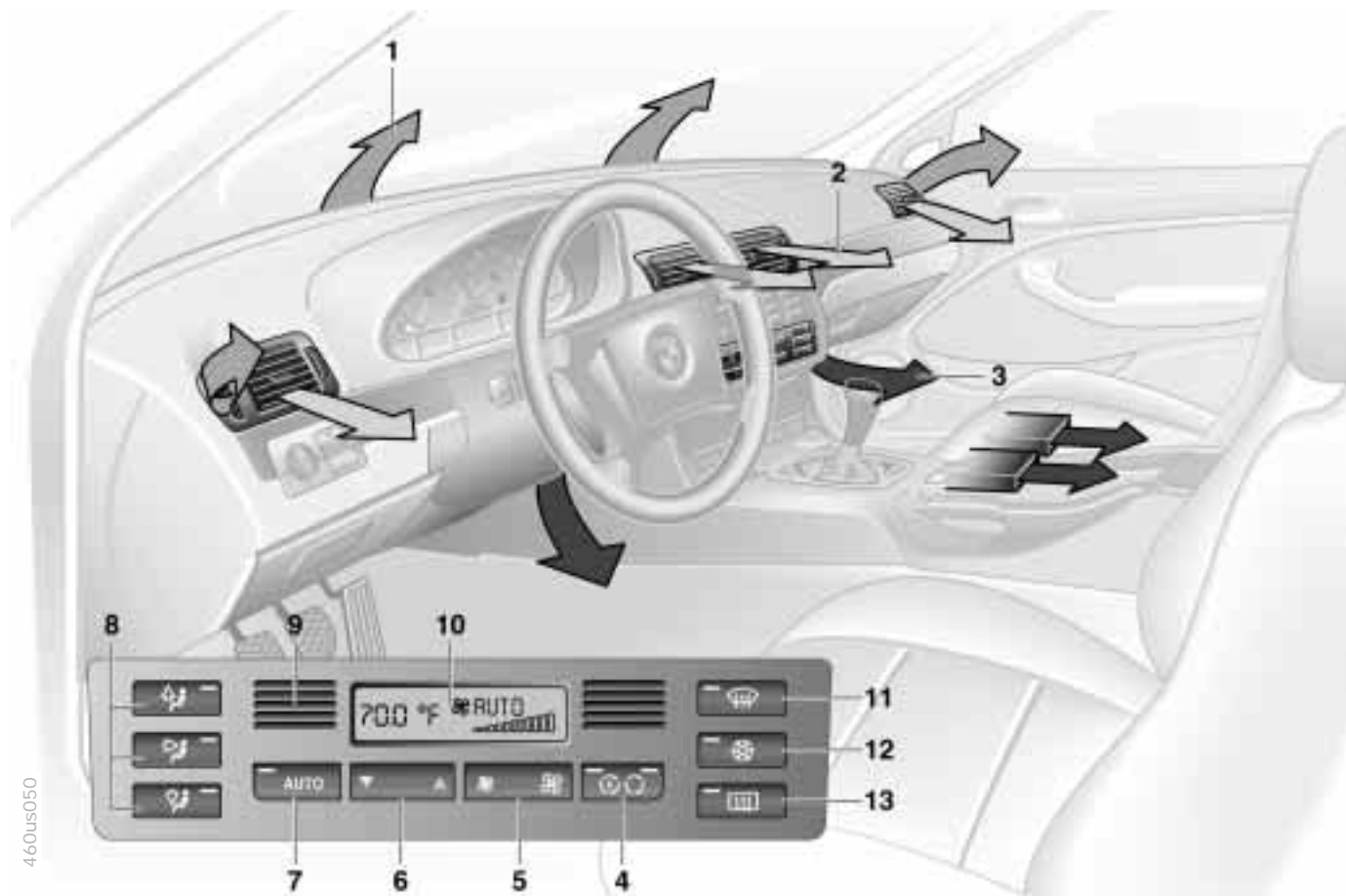



- 1 Air onto the windshield and the side windows
- 2 Air flow toward the upper body  
The side rotary dials provide infinitely-variable regulation of the air supply, while the levers change the air-flow direction. The center rotary dial controls the temperature of the air as it flows out. Refer to page [100](#)
- 3 Front footwell ventilation  
There are corresponding air vents in the rear footwell as well
- 4 Recirculated air mode/Automatic recirculated air control (AUC) [99](#)
- 5 Air supply [99](#)
- 6 Temperature [98](#)
- 7 Automatic air distribution [98](#)
- 8 Individual air distribution [98](#)
- 9 Air grill for interior temperature sensor – please keep clear and unobstructed
- 10 Display for temperature and air supply [98](#)
- 11 Defrost windows and remove condensation [99](#)
- 12 Air conditioner [99](#)
- 13 Rear window defroster [70](#), [99](#)

**Tips for pleasant driving**

Use the automatic system (switch on AUTO button 7). Select an interior temperature that is comfortable for you – we recommend +72 °F (+22 °C). When the outside temperature is above +41 °F (+5 °C), you can also use the air conditioner 12. This will dry the air as well as preventing condensation on the window surfaces – if there are passengers with damp clothing, for example. Set the outlets 2 so that the air flows past you and is not directed straight at you. Set the rotary dial between the air outlets 2 for the upper body to a medium position, since air that is somewhat cooler promotes driving without fatigue.



Detailed setting options are described for you in the following section.

**Automatic air distribution**

The AUTO program assumes the adjustment of the air distribution and the air supply for you and adapts the temperature to external influences (summer, winter) to meet preferences you can specify. This program maintains a comfortable in-car climate regardless of the season. Select an interior temperature that is comfortable for you – we recommend +72 °F (+22 °C). The selected temperature and  AUTO for the air flow appear in the display 10 (refer to the overview on page 96). Open the air outlets for the upper body area. Switch on the air conditioner in warm weather. The maximum cooling capacity is achieved when you set rotary dial 3 (refer to page 100) to cold.

**Individual air distribution**

You can cancel the AUTO program by selecting specific distribution patterns to suit your own individual requirements.

You can direct air to flow onto the windows , toward the upper body  and into the footwell .

**Temperature**

The figures in the display provide a general indication of interior temperature. We recommend +72 °F (+22 °C) as a comfortable setting, whether the air conditioner is operating or not. When you start the vehicle, the system ensures that the selected temperature is reached as quickly as possible. It then maintains this temperature, regardless of the season.

Set rotary dial 3 (refer to "Draft-free ventilation" on page 100) to a medium setting, since air that is somewhat cooler promotes driving without fatigue. You can use this setting for mixing air to make minor comfort modifications.



You can set uncontrolled heater output up to +90 °F (+32 °C). At +60 °F (+16 °C), full cooling output is available from an activated air conditioner. ◀

## Air supply

 By pressing the left or right half of the button, you can vary the air supply. By doing this, you switch off the automatic control for the air supply. Nevertheless, the automatic air distribution remains unchanged.

When you set the lowest blower speed by pressing the left half of the button, all of the displays are canceled: the blower, heating and air conditioner are switched off, and the air supply stops. You can reactivate the system by pressing any button of the automatic climate control.

## Defrost windows and remove condensation

 This program quickly removes ice and condensation from the windshield and side windows.

## Air conditioner

 The air is cooled and dehumidified and – depending on the temperature setting – rewarmed when the air conditioner system is switched on. Depending on the weather, the windshield may fog over briefly when the engine is started. Use the button to switch the air conditioner off when outside air temperatures are below approx. +41 °F (+5 °C). This will help to prevent the windows from fogging up. If the windows fog over after switching the air conditioner off, switch it back on.

 Condensation forms in the air conditioner system during operation, that then exits under the vehicle. Traces of condensed water of this kind are thus normal. ◀

## Automatic recirculated air control (AUC)

 You can respond to unpleasant external odors by temporarily blocking the outside air. The system then recirculates the air already within the vehicle. By repeated actuation of the button, you can select one of three different operation modes.

- ▷ Indicator lamps off: fresh air flows into the vehicle.
- ▷ Left-hand indicator lamp on – AUC mode: the system detects pollutants in the outside air and responds by deactivating the outside air flow as required. The system then recirculates the air already within the vehicle. Depending on air quality requirements, the system automatically switches between outside air supply and recirculation of the air already within the vehicle.
- ▷ Right-hand indicator lamp on: the flow of outside air is permanently blocked. The system recirculates the air already within the vehicle.

 If the windows fog over in the recirculated air mode, switch this mode off and increase the air supply as required. ◀

## Rear window defroster

 When the rear window defroster is turned on, the indicator lamp comes on; refer to page 70.

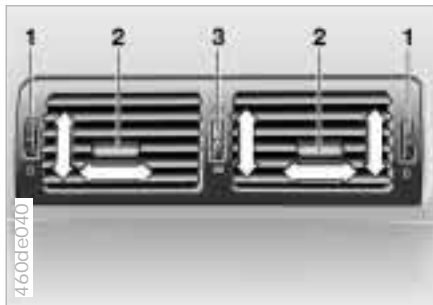

### **Draft-free ventilation**

You can adjust the blower controls for the upper body area to select the optimum airflow rates and directions for your personal comfort:

Use rotary dials 1 to open and close the air outlets through an infinitely-variable range. You can adjust the direction of the airflow with rotary dial 2.

Set the air outlets so that the air flows past you and is not directed straight at you.

The rotary dial 3 allows you to mix the air from the outlets for the upper body with more or less cool air.

### **Microfilter/Activated-charcoal filter**

The microfilter has been installed to catch any incoming dust and pollen. The activated-charcoal filter provides additional protection by filtering gaseous pollutants from the outside air. Your BMW center can replace the combined filter as a standard part of your scheduled maintenance. A substantial reduction in air flow indicates that the filter needs to be replaced early.

For additional information on filter removal, refer to page [165](#).

### **Seat heating\***



The seat cushion and backrest can be heated with the ignition key in position 2.

You can call up different heating modes by repeatedly pressing the buttons.

When the three indicator lamps are illuminated, the highest heating mode is activated. One lamp indicates the lowest heating mode. The temperature is regulated with a thermostat in each mode.

You can also switch the higher heating modes off directly: Press and hold the button slightly longer.



### HiFi system – harman kardon

Special acoustical effects are activated or deactivated every time you press the button.

When the system is activated, the impression of a significantly larger passenger compartment is created at all seating areas, together with an improvement of the stereo effect.

When reception is weak, the system frequently switches between stereo and mono operation. Switch off if this occurs.



### To open

Pull the handle. The lamp comes on.

### To closing

Fold the door up.

### To lock

Lock with one of the master keys. A master key can also be used for unlocking.

 If you turn over only your door and ignition keys for valet parking (refer to page 32), for instance, access to the glove compartment is not possible. ◀

 To prevent injury in the event of a crash, close the glove compartment immediately after use. ◀

### Rechargeable flashlight

The flashlight is located on the left-hand side of the glove compartment. It features integral overload-protection so it can be left in its holder continuously.

 Be sure that the flashlight is switched off when it is inserted into its holder. Failure to comply with this precaution could lead to overcharging and damage. ◀

## 102 Storage compartments



Open the storage compartment in the front center armrest\*: press the button (arrow) and lift upward.

You will find additional storage areas in the front doors and in the center console above the ashtray. Storage nets\* are located on the backs of the front seats.

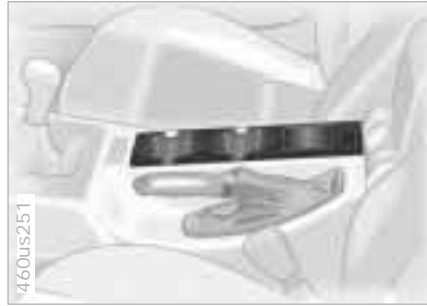

### **Beverage holder, coin box**

A coin box and two beverage holders are provided in the center console.

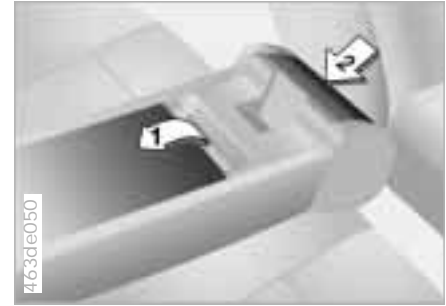

### **Rear center armrest**

There is a storage compartment, a beverage holder (for two drinks) and a garbage bag holder located in the rear center armrest.

- 1 Storage compartment: pull upward (1)
- 2 Beverage holder: press (2)

## Storage compartments



### Storage package\*

For your convenience, there are:

- ▷ Two flip-out sockets on the rear center console (arrows).
- ▷ An eyeglasses compartment\* (not shown in the illustration) in the front center console above the ashtray.

Additional storage areas are located under both the cargo area and under the spare wheel/space-saver tire panel.

## Cellular phone\*

103



### Hands-free system

On vehicles that are wired for a telephone\*, the cover for the hands-free microphone is located in the headliner near the interior lamp.

For further information on the cellular phone, refer to the separate Owner's Manual.



### To open

Press briefly in the direction indicated by the arrow.

To extinguish a cigarette, tap off the ash and gently press the tip into the funnel.



### To empty

Open the lid and press down (arrow): You can now pull the ashtray upward for removal.



Press the lighter in. It can be removed as soon as it pops up.

 Hold or touch the hot cigarette lighter by the knob only. Holding or touching it in other areas could result in burns.

The cigarette lighter remains operational when the ignition key has been removed. For this reason, children should never be left in the vehicle unattended. ◀

### Cigarette lighter socket

This socket can be used for connecting a flashlight, car vacuum cleaner, or other appliances up to approx. 200 watts at 12 volts. Avoid damaging the socket due to inserting plugs of different shapes or sizes.



## Ashtray, rear



### To open

Push the cover open.

### To empty

Press on the edge of the raised cover in the opening direction (arrow). You can now pull the ashtray upward for removal.

## Power outlet



A flip-out socket (12 V) is located in the luggage compartment.

The ski bag allows the safe and clean transport of up to four pairs of standard skis or up to two snowboards.

The length of the ski bag and the additional space provided in the luggage compartment make it possible to carry skis up to 6.8 feet long (2.10 meters). Because of the tapered shape of the bag, the ski bag can only accommodate two pairs of skis that are 6.8 feet (2.10 meters) long.



### Loading

- 1 Fold the center armrest outward. Loosen the trim from the upper Velcro® fastener and place it on the armrest.
- 2 Press the button (arrow 1) from inside the passenger compartment: the cover panel will fall to the luggage compartment floor.
- 3 Press the detent lever (arrow 2) downward and fold the cover to the front.
- 4 Extend the ski bag between the front seats. The zipper provides convenient access to the inside of the bag, and can also be left open to promote drying.

To store the ski bag, perform the above steps in reverse sequence.

 Secure the skis or other objects in the bag by tightening the strap with the buckle. ◀

Please be sure that the skis are clean before loading them into the bag. Be careful to avoid damage from sharp edges.

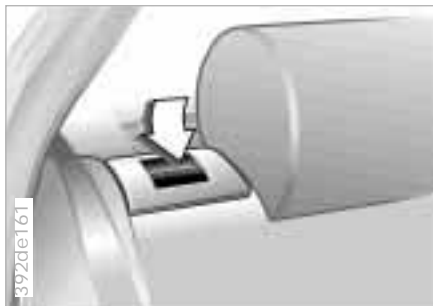

## Rear backrest that can be folded forward

Reach into the recess and pull forward (arrow).

The backrest of the rear seat is divided into two portions, one-third and two-thirds of the seat respectively. You can fold either section of the backrest down separately in order to increase the capacity of the luggage compartment.

 When you close the backrest, be sure that the catch engages securely. The red warning indicator disappears into the recess. ◀

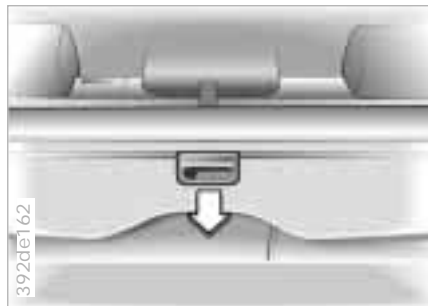

## Roll-up cover

Pull the roll-up cover out and hook it into the brackets.

The cover will support light objects such as items of clothing.

 Never put any heavy or hard objects onto the roll-up cover, otherwise, vehicle occupants could be injured during braking or in an accident. Do not allow the cover to snap back, since this could damage it. ◀

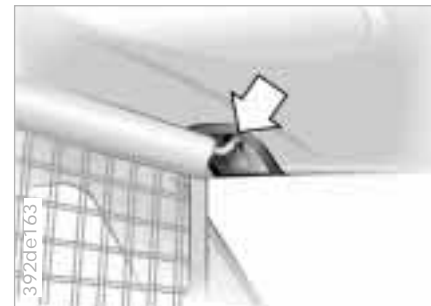

## Partition net\*

Pull the partition net out by the straps. Hold the bar on both sides and insert it into the holder. It is easiest to do this from the back seat.

 Do not allow the partition net to snap back. Doing so could cause injury and the partition net could be damaged. ◀

When the rear backrests are folded down, you can store the cassette on the back of the seats, pull the partition net out from there and insert it in the front holders (refer to the next page).

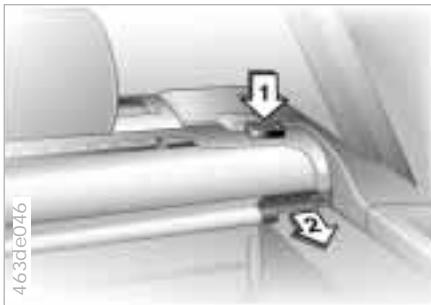

**Remove the roll-up cover and partition net**

- 1 Press the side buttons simultaneously (arrow 1).
- 2 Pull the cassette out the back (arrow 2).

**Installation**

Simply slide the cassette forward in the two side holders until it engages.



**Store with rear backrest folded down**

The take-up guides for the cassette are attached to the back sides of the seat-backs (arrows 1).

As shown in the illustration, push the cassette in from the right side until it clicks into place (arrow 2). When doing this, the roll-up cover must always point in the direction of travel, and the strap for the partition net must point upward.

You can pull the partition net out and insert it in the holders above it in the upper roof area.

 The cassette always has to be pushed all the way into both guide rails from the right side, or else it might be jammed in asymmetrically. In addition, the door's interior paneling could be damaged when shutting the door. ◀



## Floor panel

To raise and secure the floor panel, lift it by the ring and hook it into the rubber seal of the run-off gutter with the hanger (arrow).



## Side covers

Open the side covers by pressing the button.

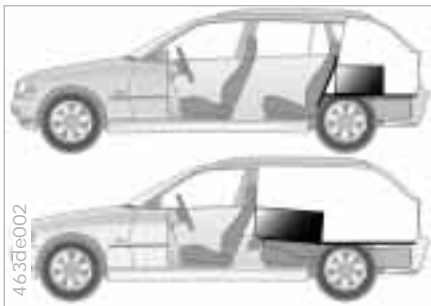

### Stowing cargo

If you are transporting a load in your BMW:

- ▷ Load heavy cargo as far forward as possible – directly behind the backrests or the luggage compartment partition – and as low as possible.
- ▷ Cover sharp edges and corners.
- ▷ Do not pile objects higher than the top edge of the backrest.
- ▷ Pull the partition net\* out (refer to previous page). Be sure that items carried in the rear cannot slip through the partition net\*.
- ▷ If you are transporting very heavy loads when the rear seat is not occupied, secure the outer safety belts in the opposite buckles.



### Securing the load

- ▷ Secure smaller, light pieces with the retaining straps or a luggage net\*, or use luggage straps (refer to page 40).
- ▷ For large, heavy pieces, see your BMW center for load-securing devices\*. Use the lashing eyes (arrow) affixed to the four inside corners in the luggage compartment for securing the load.
- ▷ Comply with the information enclosed with the load-securing devices.

 Always position and secure the load correctly. If you do not, it can endanger the passengers during braking or evasive maneuvers. Do not exceed the permissible gross vehicle weight and the permissible axle loads (refer to page 186). If you do, safe operation of the vehicle is no longer ensured, and you are in violation of the law.

Do not carry hard or heavy objects unsecured in the passenger compartment. If you do so, they may be projected through the air during braking and evasive maneuvers, thus endangering vehicle occupants. ◀

## Roof-mounted luggage rack\*

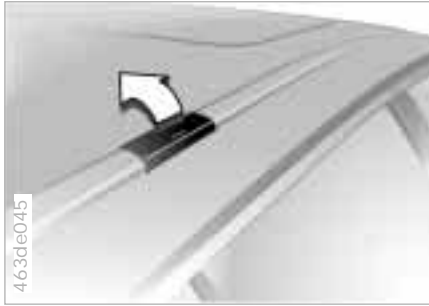

### Mounting points

Access to the mounting points:  
To fold up the cover (arrow), please use the tool which is provided with the luggage system.

A special luggage system is available as an option for your BMW. Please observe the precautions included with the installation instructions.

Because roof racks raise the center of gravity of the vehicle when loaded, they exercise a major effect on its handling and steering response.

You should therefore always remember not to exceed the approved roof weight, the approved gross vehicle weight or the axle weights when loading the rack. You will find the specifications under "Technical Data" on page [186](#).

Make sure that the load is not too heavy, and attempt to distribute it evenly. Always load the heaviest pieces first (on the bottom). Be sure that adequate clearance is maintained for raising the sliding/tilt sunroof, and that objects do not project into the opening path of the tailgate.

Secure the roof luggage correctly and tightly to prevent it from shifting or being lost during driving (danger to following traffic).

Drive smoothly and avoid sudden acceleration or braking. Do not corner at high speeds.

The roof load increases aerodynamic resistance, resulting in increased fuel consumption and additional stresses on the vehicle's body.





**Special operating instructions:**

- Break-in procedures 114
- Driving notes 115
- Catalytic converter 115
- Antilock Brake System (ABS) 116
- Disc brakes 118
- Brake system 120
- Winter operation 121
- Power steering 123
- Cellular phone 123
- Radio reception 123

**Wheels and tires:**

- Tire inflation pressure 124
- Tire condition 124
- Tire replacement 125
- Tire rotation 126
- Wheel and tire combinations 127
- Winter tires 128
- Snow chains 128
- Approved wheel and tire specifications 129

**Under the hood:**

- Hood 130
- Engine compartment 132
- Washer fluids 134
- Washer nozzles 134
- Engine oil 135
- Coolant 137
- Brake fluid 138
- Vehicle Identification Number 139

**Care and maintenance:**

- The BMW Maintenance System 140
- Caring for your vehicle 141
- Airbags 147
- Vehicle storage 147

**Laws and regulations:**

- Technical modifications 148
- California Proposition 65 Warning 148
- OBD interface socket 149

**Overview****Controls and features****Operation, care and maintenance****Owner service procedures****Advanced technology****Technical data****Index**

To ensure maximum economy and a long service life, we request that you observe the following suggestions.

### **Engine and differential**

Up to 1,200 miles (2,000 km):

Drive at varying engine speeds and road speeds, but do not exceed the following engine or road speeds during this time: 4,500 rpm or 100 mph (160 km/h).

Obey your local and state maximum speed limits.

Refrain from using full throttle and avoid pressing the accelerator beyond the "kickdown" point.

After you have driven 1,200 miles (2,000 km), you can gradually increase the engine and road speeds.

You should also comply with these break-in procedures if the engine or differential is replaced at a later point.

### **Tires**

Due to technical factors associated with their manufacture, tires do not achieve their full traction potential until an initial break-in period has elapsed. Thus drive with extra care during the initial 200 miles (300 km).

Obey your local and state maximum speed limits.



When the vehicle is operated on wet or slushy roads, a wedge of water may form between the tire and the road surface. This phenomenon is referred to as aquaplaning, or hydroplaning, and can lead to partial or complete loss of traction, vehicle control and braking effectiveness. Reduce your speed on wet roads. ◀

### **Brake system**

After approximately 300 miles (500 km), the brake pads and discs achieve the optimal pad surface and wear patterns required for trouble-free operation and long service life.

To break in the separate parking brake drums, apply the parking brake lightly when coasting to a standstill (at a traffic signal, for instance), provided that traffic conditions allow you to do so. To avoid corrosion, repeat this procedure from time to time.



The brake lamps do not come on when the parking brake is applied. Vacuum for the brake system servo unit on your BMW is available only when the engine is running. When you move the vehicle with the engine off – when towing, for example – substantially higher levels of pedal force will be required to brake the vehicle. ◀

### **Clutch**

The clutch will also begin to function optimally after about 300 miles (500 km). Engage the gears carefully during the break-in period.



### Brakes:

Do not drive with your foot resting on the brake pedal. Even light but consistent pedal pressure can lead to high temperatures, brake wear, and possibly to brake failure.

### Aquaplaning:

When driving on wet or slushy roads, reduce vehicle speed. If you do not, a wedge of water may form between the tires and the road surface. This phenomenon is referred to as aquaplaning or hydroplaning. It is characterized by a partial or complete loss of contact between the tires and the road surface. The ultimate results are loss of steering and braking control.

### Driving through water:

When there is water on the roads, do not drive in it if it is deeper than 1 ft (30 cm), and then only at walking speed at the most, otherwise the vehicle can sustain damage to the engine, the electrical systems and the transmission.

### Roll-up cover:

Never use the rear window shelf to store heavy or bulky objects. If you do so, such objects could injure vehicle occupants during braking or evasive maneuvers or in a crash.

### Clothes hooks:

When suspending clothing from the hooks, ensure that they will not obstruct the driver's vision. Do not hang heavy objects on the hooks. If you do, such objects could pose the risk of personal injury during braking or evasive maneuvers. ◀

The catalytic converter reduces harmful exhaust emissions, and is designed for use with unleaded fuel only. Even minute quantities of lead would be enough to permanently damage both the catalytic converter and the system oxygen sensor.

To ensure efficient, trouble-free engine operation and to avoid potential damage:

- ▷ Be sure to comply with the scheduled maintenance requirements.
- ▷ Fill the fuel tank well before it is empty.
- ▷ Tow-start only when the engine is cold. If you attempt to tow-start with a warm engine, unburned residual fuel in the catalytic converter could ignite and cause damage. It is better to start the vehicle with an outside starting aid.
- ▷ Avoid other situations in which the fuel is not burned, or burns incompletely, such as engaging the starter frequently or for extended periods, or repeated start attempts in which the engine does not start (stopping and restarting an engine which is running properly does not present a problem). Never allow the engine to run with any of the spark plug cables disconnected.



Be sure to observe the instructions above to prevent unburned fuel from reaching the catalytic converter, otherwise, the catalytic converter could overheat and be damaged.

High temperatures occur in any vehicle equipped with a catalytic converter. Heat shields are installed adjacent to some sections of the exhaust system. Never remove these shields; do not apply undercoating to their surfaces. When driving, standing at idle, and parking the vehicle, take care to avoid contact between the exhaust system and flammable materials (grass, hay, leaves etc.). Such contact could lead to a fire, resulting in personal injury and property damage. ◀

## Antilock Brake System (ABS)

### The concept

ABS enhances active driving safety by helping to prevent the wheels from locking under braking. The reason: locked wheels are dangerous. When the front wheels slide, the driver loses steering control over the vehicle. Traction loss at the rear wheels can cause the rear end to break into an uncontrolled skid.

The system can achieve the shortest braking distances possible under most conditions (on straight-aways and in curves, on asphalt, ice, wet road surfaces, etc.).

ABS is designed to meet two essential requirements during every brake application:

- ▷ To help provide vehicle stability.
- ▷ Assured ability to steer and maneuver – on the various road surfaces (asphalt, concrete, dirt, wet conditions, snow, ice).

The system can achieve the shortest braking distances possible under most conditions (on straight-away and in curves, on asphalt, ice, wet road surfaces, etc.).

### Braking with ABS

The system is operative once the vehicle exceeds a speed of approx. 6 mph (10 km/h). It is deactivated once again below approx. 4 mph (6 km/h). This means that the wheels can lock in the final phase of a panic stop – a factor of no significance in actual use.

If you are in a situation that requires full braking, you will exploit the full benefits of the ABS system if you apply maximum brake pressure ("panic stop"). Since the vehicle maintains steering responsiveness, you can nevertheless avoid possible obstacles with a minimum of steering effort.

The ABS closed-loop control circuit cycles in fractions of a second. A pulsation at the brake pedal, together with the sounds associated with the hydraulic controls, tells you that the brake system is within its maximum limit range, and reminds you that you should adapt road speed to the road conditions.

On road surfaces that have a loose surface layer on a firm base with good traction (on gravel or snow, for example), or when snow chains are mounted, braking distances may be longer than with locked wheels.

## Antilock Brake System (ABS)

Nevertheless, ABS possesses the advantage of vehicle stability and steering response.

### Information for your safety

Not even ABS can suspend the laws of physics. The consequences of brake applications with inadequate clearances for safety between vehicles, excessive speed or if aquaplaning occurs are always the responsibility of the driver. You should never allow the added safety of ABS to lull you into a false sense of security, or mislead you into taking risks that could affect your own safety and that of others.

 Do not make any modifications to the ABS system. Service procedures on ABS are to be performed by authorized technicians only. ◀

### Antilock Brake System (ABS)/ Cornering Brake Control (CBC)

CBC is an advanced engineering development of ABS. When braking while cornering at high speed or braking during high lateral acceleration, or when braking during a lane change, vehicle stability is improved and steering response is enhanced.

### In the event of a malfunction

 If the ABS warning lamp in the instrument cluster lights up, refer to page 22. The brake system then reverts to conventional operation as on vehicles without ABS. However, have the brake system checked by your BMW center as soon as possible. To prevent undetected defects and cumulative faults from adversely affecting the brake system, refer any problems to your authorized BMW center at the earliest opportunity.

 ABS warning lamp for Canadian model.

 If the brake warning lamps light up together with the indicator lamps for ABS and ASC+T/DSC – refer to page 19 – then the entire regulating system, the ABS, CBC and ASC+T/DSC and ADB/ ADB-X/DBC have failed. Continue driving cautiously and defensively. Avoid full brake applications. This could cause the vehicle to lose stability and you might no longer be able to control it. Have the system checked by your BMW center as soon as possible.



CBC, ABS und ASC+T/DSC indicators and warning lamps for Canadian models.

### **Dynamic Brake Control (DBC)\***

DBC is included in the DSC, refer to information beginning on page 81.

If you step on the brake rapidly, this system automatically produces maximum braking force boost and thus helps to achieve the shortest possible braking distance during "panic stops." All of the benefits of the ABS system are exploited under these circumstances.

Do not reduce the pressure on the brake pedal for the duration of the brake application. When the brake pedal is released, the DBC is deactivated.



In the event of a malfunction, the yellow warning lamp comes on. Normal braking efficiency and the anti-lock braking system are still fully available.

Have the system checked and repaired at your BMW center as soon as possible.



Refer to the "Information for your safety" covering the ABS system. This information also generally applies for DBC. ◀

## **Disc brakes**

Disc brakes furnish optimum deceleration and braking control and greater fade resistance under heavy use.

When the vehicle is driven only occasionally, during extended periods when the vehicle is not used at all, and in operating conditions where brake applications are less frequent, there is an increased tendency for corrosion of the discs and accumulation of contamination on the brake pads. This occurs because the minimal pressure that must be exerted by the pads to clean the discs by brake applications is not reached.

If the brake discs are corroded, they will tend to respond to braking with a pulsating effect that even extended brake applications will fail to cure.



For your own safety: use only brake pads which BMW has approved for your specific vehicle model. BMW cannot evaluate non-approved brake pads to determine if they are suited for use, and therefore cannot ensure the operating safety of the vehicle if they are installed. ◀

# Disc brakes

## Driving notes

When driving in wet conditions and in heavy rain, it is effective to apply light pressure to the brakes every few miles or kilometers. Watch traffic conditions to ensure that this maneuver does not endanger other drivers. The heat which is generated by the brake applications helps to dry the brake pads and discs.

Maximum braking force is obtained while the wheels are not locked, but rather when they are still barely turning immediately prior to locking. ABS maintains this state automatically. If the ABS fails, you should revert to the staggered braking technique (refer to page [122](#)).

Extended or steep mountain descents should be driven in the gear in which only minimal periodic brake application is required. This avoids excessive strain on the brakes and possible impairment of the braking effect.

The braking effect of the engine can be further increased by downshifting, into first gear, if necessary. In the manual mode of the automatic transmission, you can also downshift into first gear. Refer to page [66](#).

If engine braking should prove to be inadequate, you should still avoid extended, continuous braking. Instead of maintaining low to moderate pressure over an extended period of time, you should decelerate by applying more substantial pressure to the brake pedal (watch for following traffic), releasing the pedal, and then repeating the application (staggered braking). The cooling phases between active braking intervals prevent the brakes from overheating, thus ensuring that full braking capacity remains available at all times.



Do not allow the vehicle to coast when the clutch is depressed or by shifting into neutral while moving. Do not drive when the engine is switched off. The engine provides no braking control when the clutch is depressed or the transmission is in "Neutral" and there is no power-assist for the brakes when the engine is shut off. BMW 325xi: have brake inspections performed at a BMW center only. If you do not, parts of the four-wheel drive system could be damaged. Do not allow floor mats, carpets or any other objects to protrude into the area around the brake pedal, the clutch or the accelerator which could obstruct their freedom of movement. ◀

### Brake fluid level



The warning lamp for the brake comes on with the parking brake released:

The brake fluid level is too low in the reservoir (refer to page [138](#)).

If the brake fluid level is too low and brake pedal travel has become noticeably longer, there may be a defect in one of the brake system's hydraulic circuits.



Brake warning lamp for Canadian models.



Proceed to the nearest BMW center. Higher brake application pressure may be necessary under these conditions, and brake pedal travel may be significantly longer. Please remember to adapt your driving style accordingly. ◀

### Brake linings



The warning lamp for the brake pads comes on:

The brake pads have reached their minimum pad thickness. Proceed to the nearest BMW center as soon as possible to have the pads replaced.



For your own safety: use only BMW approved brake pads for your specific vehicle model. BMW cannot evaluate non-approved brake pads to determine if they are suited for use, and therefore cannot ensure the operating safety of the vehicle if they are installed. ◀



## Winter operation

Winter is often accompanied by rapid changes in weather. Adaptions in driving style should be accompanied by preparations on the vehicle itself to ensure that your vehicle operates safely and trouble-free throughout the winter months.

### Coolant

Be sure that the coolant mixture contains the year-round ratio of 50:50 water and antifreeze/corrosion protection. This mixture will resist freezing to approx. -34 °F (-37 °C). Replace the coolant every four years.

### Locks

BMW door lock deicer can be used to free them if frozen. This deicer also contains lubricant. After using the deicer, treatment with BMW lock cylinder grease is recommended.

### Rubber seals and components

To prevent the weather stripping from freezing, apply a spray-on rubber treatment or silicone spray to the door, hood and tailgate seals.



A full range of car care products is available from your BMW center. ◀

### Snow chains\*

BMW snow chains can be mounted on both summer and winter tires. Mount them in pairs on the rear wheels only and comply with the manufacturer's safety precautions. Do not exceed a maximum speed of 30 mph (50 km/h). In this type of exceptional situation where the snow chains are mounted, deactivate the ASC+T/DSC. Refer to page 79.

BMW 325xi: in a worst-case scenario, i.e. if your vehicle is stuck on one side or you cannot access one tire, then only one chain may be attached to a rear wheel for a short period of time.

### Starting off

When starting off from a full stop in deep snow or when "rocking" the vehicle to free it, it may be effective to deactivate the ASC+T/DSC system for a short period. Refer to page 79.

### Driving on low-traction road surfaces

Use smooth, gentle pressure to control the accelerator pedal. Avoid excessive engine speeds and shift to the next higher gear at an early point. Downshift into the next lower gear on ascents or descents. Maintain an adequate distance between yourself and the vehicle ahead.

### **Braking**

Winter road conditions substantially reduce the amount of traction available between the tires and the road surface. Keep this in mind, because the braking distance increases substantially.

ABS is intended to prevent the wheels from locking during brake applications, thus helping to maintain vehicle stability and steering response.

If the ABS does not respond in a critical braking situation and the wheels lock: reduce the pressure on the brake pedal until the wheels just start to roll again while still maintaining enough force to continue braking.

Then increase the pressure, reduce the pressure when the wheels lock, reapply pressure etc.

This staggered braking procedure will reduce braking distances while helping you maintain steering control.

You can then attempt to steer around hazards after you have reduced pressure on the brake pedal.



Do not shift down on slick road surfaces – if you want to decelerate. Doing so could cause the rear wheels to lose traction and skid, which could result in the loss of vehicle control. ◀



Depress the clutch during hard braking on road surfaces that provide only poor or uneven traction. ◀

### **Skid control**

Depress the clutch and release the accelerator pedal, or place the selector lever of the automatic transmission into the "Neutral" position. Countersteer carefully and attempt to regain control of the vehicle.

### **Parking**

Engage 1st or reverse gear. If your vehicle is equipped with an automatic transmission, place the selector lever in "Park." On vehicles with manual transmission, also apply the parking brake when parking on inclined surfaces. In order to prevent the parking brake pads from locking due to frost or corrosion, dry them by gently applying the parking brake as the vehicle is coming to a stop. Make sure that following traffic is not endangered.



The brake lamps do not come on when the parking brake is applied. ◀

## Power steering

Changes in steering response, e. g. high steering effort:

Consult a BMW center to have the system checked.



If the power steering fails, increased effort will be required to steer the vehicle. ◀

## Cellular phone\*

Only mobile communications systems (cellular phone, radio, etc.) with an output up to 10 watts are permitted. Mobile communications devices not specifically designed for use in your vehicle may trigger malfunctions while operating your vehicle. BMW can neither test nor assume responsibility for every individual product being offered on the market. We recommend that you consult your BMW center before purchasing any device of this kind.

To ensure that your BMW continues to provide reliable and trouble-free operation, do not use a cellular phone or other radio device with an antenna located inside the passenger compartment. The antenna should always be mounted on the outside of the vehicle.



Before loading the vehicle on a car-carrier train or driving it through a car-wash, remove the antenna. ◀

## Radio reception

The reception and sound quality obtained from mobile radios vary according to a variety of factors, including the broadcast range of the transmitter and the directional orientation of the antenna. Interference factors such as high-tension power lines, structural or natural obstructions can all lead to unavoidable reception interference, regardless of how well the vehicle sound system is operating. Climatic factors such as intense solar radiation, fog, rain and snow can also interfere with reception.

Cellular or portable phones not recommended by BMW can also generate interference in the radio when making telephone calls. This phenomenon assumes the form of a low-pitched hum emanating from the speaker system.

Please refer to the Owner's Manual provided with your sound system for detailed information on its use.

**Information for your safety**

The factory-approved radial tires are matched to the vehicle and have been selected to provide optimum safety and driving comfort on your vehicle.

It is not merely the tire's service life, but also driving comfort and – above all else – driving safety that depend on the condition of the tires and the maintenance of the specified tire pressure.

Incorrect inflation pressure is a frequent cause of tire damage. It also significantly influences the roadholding ability of your BMW.

 Check the tire inflation pressure – for the space-saver spare tire or spare tire – on a regular basis (refer to page 28), at least twice a month, and before starting out on any extended trip. If this is not done, incorrect tire pressures can cause driving instability and tire damage, ultimately resulting in an accident. ◀

**Tire condition****Tire tread – tire damage**

Inspect your tires frequently for tread wear, signs of damage and for foreign objects lodged in the tread. Check the tread depth.

Tread depth should not be allowed to go below 0.12 in (3 mm), even though the legally specified minimum tread depth is only 0.063 in (1.6 mm). At a tread depth of 0.063 in (1.6 mm), tread depth indicators (arrow) in the tread-groove base indicate that the wear limit – applicable by law throughout Europe – has been reached. Below 0.12 in (3 mm) tread depth, there is an increased risk of aquaplaning, even at relatively moderate speeds and with only small amounts of water on the road.

 Never continue driving on a deflated (flat) tire. A flat tire greatly impairs steering and braking response, and can lead to complete loss of control over the vehicle.

Avoid overloading the vehicle so that the permitted load on the tires is not exceeded. Overloading can lead to overheating and increases the rate at which damage develops inside the tires. You could have a blowout as a result.

Unusual vibrations encountered during normal vehicle operation can indicate tire failure or some other vehicle defect. The same applies to irregularities related to your usual driving style, such as pulling hard to the left or right. Should this occur, respond by immediately reducing your speed. Proceed carefully to the nearest BMW center or professional tire center, or have the vehicle towed in to have it and its tires inspected.

Tire damage (up to and including sudden and complete air loss) can endanger the lives of both the vehicle occupants and other road users. ◀

# Tire replacement

To maintain good handling and vehicle response, use only tires of a single tread configuration from a single manufacturer. BMW tests and approves wheel/tire combinations. Refer to page [129](#).

## DOT Quality Grades

Treadwear

Traction AA A B C

Temperature A B C

 All passenger car tires must conform to Federal Safety Requirements in addition to these grades. ◀

## Tread wear

The tread wear grade is a comparative rating based on the wear rate of the tire when tested under controlled conditions on a specified government test course.

For example, a tire graded 150 would wear one and one-half (1½) times as well on the government course as a tire graded 100. The relative performance of tires depends upon the actual conditions of their use, however, and may depart significantly from the norm due to variations in driving habits, service practices and differences in road characteristics and climate.

## Traction

The traction grades, from highest to lowest, are AA, A, B, and C. Those grades represent the tire's ability to stop on wet pavement as measured under controlled conditions on specified government test surfaces of asphalt and concrete. A tire marked C may have poor traction performance.

 The traction grade assigned to this tire is based on straight-ahead braking traction tests, and does not include acceleration, cornering, hydroplaning, or peak traction characteristics. ◀

## Temperature

The temperature grades are A (the highest), B, and C, representing the tire's resistance to the generation of heat and its ability to dissipate heat when tested under controlled conditions on a specified indoor laboratory test wheel. Sustained high temperature can cause the material of the tire to degenerate and reduce tire life, and excessive temperature can lead to sudden tire failure. The grade C corresponds to a level of performance which all passenger car tires must meet under

the Federal Motor Vehicle Safety Standard No. 109. Grades B and A represent higher levels of performance on the laboratory test wheel than the minimum required by law.

 The temperature grade for this tire is established for a tire that is properly inflated and not overloaded. Excessive speed, under-inflation, or excessive loading, either separately or in combination, can cause heat buildup and possible tire failure. ◀

## Uniform Tire Quality Grading

Quality grades can be found where applicable on the tire sidewall between tread shoulder and maximum section width. For example:

Tread wear 200 Traction AA  
Temperature A

 Do not use retreaded tires. Driving safety may be impaired by their use. This is due to the possible variations in casing structures and, in some cases, to their extreme age, which can lead to a decrease in their durability. ◀

**Tire age**

The date on which the tire was manufactured is indicated by the code on the sidewall:

DOT ... 4100 indicates that the tire was manufactured during week 41 of the year 2000.

BMW recommends the replacement of all tires when the tires are no more than 6 years old, even if a tire life of 10 years is possible.

Spare tires over 6 years old should be used only in case of emergency. A tire of this age should be replaced by a new tire immediately, and should not be mounted together with new tires.

**Tire rotation****Between the axles**

The tread wear patterns at the front end differ from those at the rear – the actual patterns will vary according to individual driving conditions. In the interests of safety and maintaining optimal handling characteristics, tire rotation is not recommended.

If a proposed interaxle rotation of tires is based on economic considerations, one should consider whether the costs for the rotation are likely to be recaptured by any increase in the service life of the tires that might be realized. In principle, interaxle rotation must be performed in short intervals, with a maximum of 3,000 miles (5,000 km). Consult your BMW center for more information.

Should you decide to rotate the tires, it is essential to comply with the following: Rotate tires on the same side only, since braking characteristics and road grip could otherwise be adversely affected.

Following rotation, the tire inflation pressure should always be corrected.



If different tire sizes are mounted on the front and rear axles (refer to page 129), the wheels may not be rotated from one axle to the other. ◀

## The right choice

Use only tires approved by BMW.

Refer to the information beginning on page 129.

Due to the high speeds this vehicle can reach, the use of specific brands, specifications and sizes is mandatory.

Consult any BMW center for details. Comply with local/national regulations.



The correct wheel-tire combination affects different systems such as ABS, ATC and ASC+T/DSC. The function of these systems is impaired if improper wheel-tire combinations are used.

For this reason, use only tires of the same brand and tread pattern. In the event of a flat tire, for example, remount the approved wheel-tire combination as soon as possible. ◀

## Codes on tires and wheels

The tire codes will aid you in selecting the correct tire.

Codes on radial tires:

For example: 205/60 R 15 91 W

Nominal width in mm	205	/	60	R	15	91	W
Aspect ratio in %			60				
Radial tire code				R			
Rim diameter in inches					15		
Load rating (not on ZR tires)						91	
Speed rating (before R on ZR tires)							W

The speed rating indicates the approved maximum speed for the tire.

Summer tires:

S = up to 112 mph (180 km/h)  
T = up to 118 mph (190 km/h)  
H = up to 130 mph (210 km/h)  
V = up to 150 mph (240 km/h)  
W = up to 167 mph (270 km/h)  
Y = up to 187 mph (300 km/h)  
ZR = over 150 mph (240 km/h)

Winter tires:

Q M+S = up to 100 mph (160 km/h)  
T M+S = up to 118 mph (190 km/h)  
H M+S = up to 130 mph (210 km/h)

Codes stamped on light-alloy wheels:

For example: 7 J x 15 H 2

Rim width in inches	7	J	x	15	H	2
Code letter for flange type		J				
Symbol for full-drop center rim			x			
Rim diameter in inches				15		
Hump on the 2 rim shoulders						2

Protect tire valves from dirt by using screw-on valve stem caps. Dirt in the valves frequently leads to slow leaks.

**Choosing the right tire**

BMW recommends winter tires (M+S radial tires) for driving in adverse winter road conditions. So-called all-season tires with the M+S-identification mark do indeed possess better winter traction than summer tires with the load rating H, V, W, Y und ZR, but usually do not achieve the same level of performance as winter tires.

In the interests of safe tracking and steering response, install radial tires made by the same manufacturer and with the same tread configuration on all four wheels if you elect to mount winter tires.

Mount only winter tires which have been approved by BMW. Any BMW center will be glad to provide you with information on the best winter tires for your particular driving conditions.

**Do not exceed specified maximum speeds**

Never exceed the maximum speed for which the tires are rated.

Unprofessional attempts by laymen to service tires can lead to damage and accidents.

Have this work performed by skilled professionals only. Any BMW center has the required technical knowledge and the proper equipment and will be happy to assist you. ◀

**Tire condition, tire pressure**

Once the tire wears to below 0.16 in (4 mm), winter tires display a perceptible decrease in their ability to cope with winter driving conditions, and should be replaced in the interest of safety.

Comply with the specified tire inflation pressures – and be sure to have the wheel and tire assemblies balanced every time you change the tires.

**Storage**

Always store tires in a cool, dry place. Store them away from light whenever possible. Protect the tires against contact with oil, grease and fuel.

**Snow chains\***

The use of narrow-link BMW snow chains on summer or winter tires is approved only in pairs and only on the rear wheels. Comply with all manufacturer's safety precautions when mounting the chains.

BMW 325xi: in a worst-case scenario, i.e. if your vehicle is stuck on one side or you cannot access one tire, then only one chain may be attached to a rear wheel for a short period of time.

Comply with all manufacturer's safety precautions when mounting the chains.



Tire specifications	Steel rim (wheel rim)	Light-alloy wheel
<b>All season tires</b>		
205/55 R 16 91 H M+S	7Jx16	7Jx16
205/50 R 17 93 V M+S extra load	7Jx17	7Jx17
<b>Summer tires</b>		
205/55 R 16 91 V 225/50 R 16 92 W 225/50 ZR 16	-	7Jx16
205/50 R 17 93 W extra load	-	7Jx17
225/45 R 17 91 W	-	8Jx17
Front: 225/45 ZR 17 Rear: 245/40 ZR 17	- -	7.5Jx17 8.5Jx17
<b>Winter tires</b>		
205/55 R 16 91 Q M+S 225/50 R 16 92 Q M+S (not 325xi)	7Jx16	7Jx16
205/50 R 17 93 Q M+S extra load	7Jx17	7Jx17
225/45 R 17 91 Q M+S	-	8Jx17
<b>Spare wheel</b>		
T 115/90 R 16 92 M	3.0Bx16	
T 125/90 R 16 98 M	3.5Bx16	-
T 125/80 R 17 99 M	3.5Bx17	-

Comply with the specifications for tires and wheels in the vehicle documents. If you install tire sizes not approved by the manufacturer, this information must be entered in the vehicle documents.

## BMW 325xi

For all tires, only light-alloy wheels must be used.

## Snow chains\*

You cannot mount snow chains on the following tires:

225/50 R 16 92 W  
225/50 R 16 92 Q M+S  
225/50 ZR 16  
225/45 R 17 91 W  
225/45 R 17 91 Q M+S  
225/45 ZR 17

## Mixed tires

For details concerning tire manufacturers for mixed tires, refer to the vehicle documents.

 Do not work on your vehicle without appropriate skills. Always switch off the engine and allow it to cool down before working in the engine compartment. Always disconnect the battery before working on any electrical systems or equipment, especially when these are located within the engine compartment. Comply with all applicable instructions and warnings. Failure to work in an informed, professional manner when servicing components and materials constitutes a safety hazard for vehicle occupants and other road users. If you are not familiar with the guidelines, please have the operations performed by your BMW center. ◀

**To unlock**

Pull the lever located under the left-hand side of the dashboard.

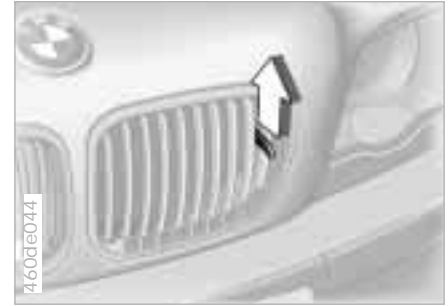
**To open**

Pull the release handle and open the hood.

# Hood



## To close

Allow the hood to fall from a height of about 12 in (30 cm) so that it audibly engages.



To avoid injuries, be sure that the travel path of the hood is clear when it is closed, as with all closing procedures.

If it is determined that the hood is not completely closed while driving, stop immediately and close it securely. ◀

132 Engine compartment - BMW 325i, 325xi

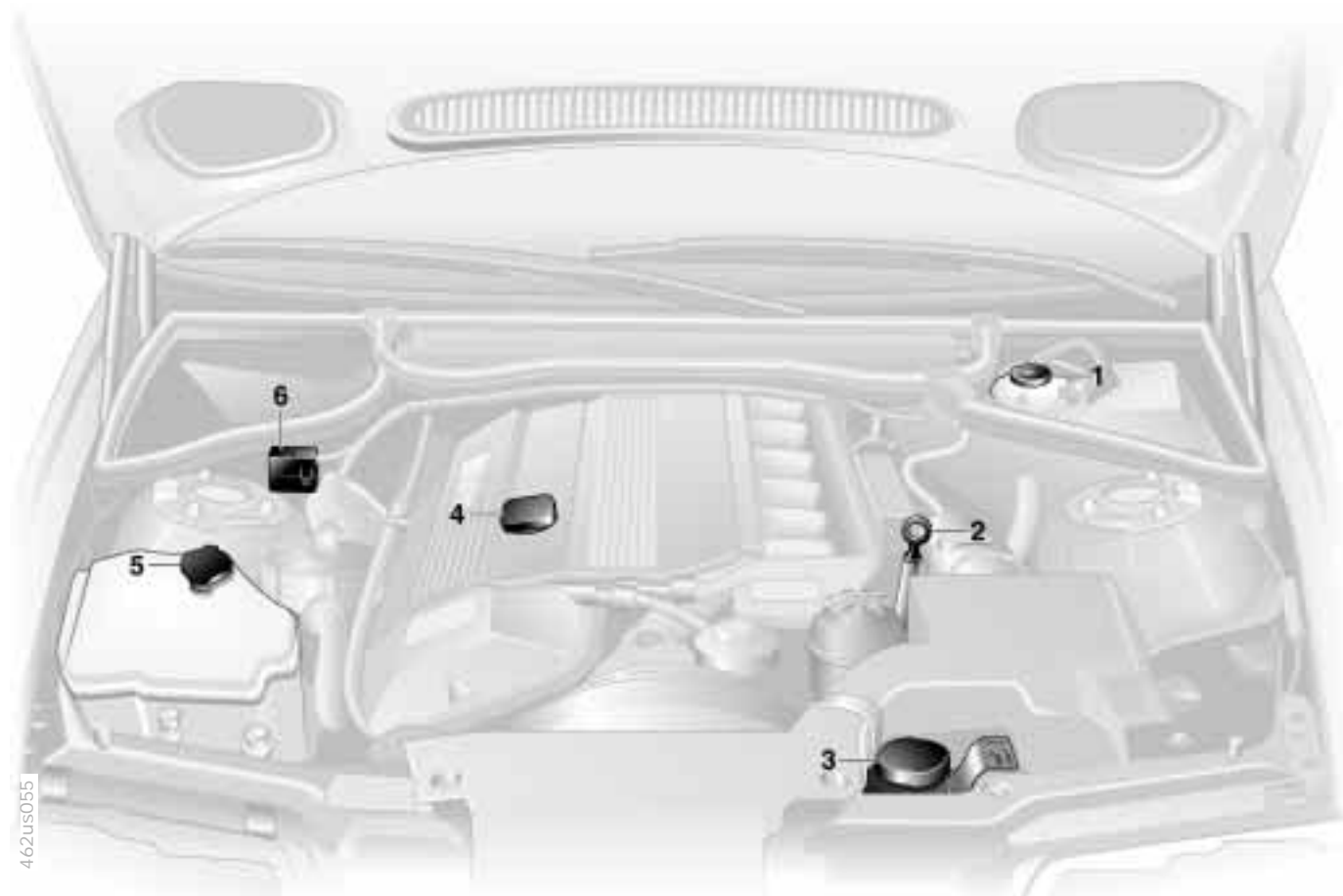

# Engine compartment – BMW 325i, 325xi

- 1 Brake fluid reservoir [138](#)
- 2 Engine oil dipstick [135](#)
- 3 Coolant expansion tank [137](#)
- 4 Engine oil filler neck [135](#)
- 5 Reservoir for the headlamp\* and windshield washer system [134](#)
- 6 Auxiliary terminal for jump starting [167](#)

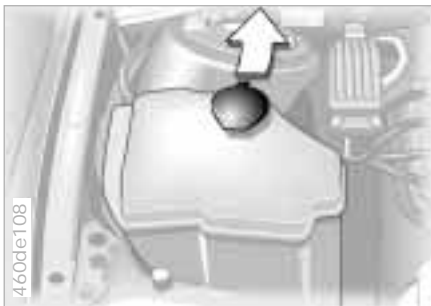

### Headlamp\* and windshield washer system

Capacity: approx. 5.6 US quarts (5.3 liters).

Fill with water and – if required – with a washer antifreeze (according to manufacturer's recommendations).

 We recommend that you mix the washer fluid before adding it to the reservoir. ◀



### Windshield washer system (rear window)

Capacity: approx. 2.4 US quarts (2.3 liters).

Fill with water and – if required – with a washer antifreeze (according to manufacturer's recommendations).

 We recommend that you mix the washer fluid before adding it to the reservoir. ◀

 Antifreeze for the washer systems is flammable. For this reason, keep it away from sources of flame and store it only in its original containers. Store it so that it is inaccessible to children. Comply with the instructions on the containers. ◀

## Washer nozzles

### Windshield washer

The spray from the nozzles should be directed at the front windshield and the rear window in such a way they will be properly cleaned even at high speeds. Use a needle to adjust the nozzles as required, or have them adjusted by your BMW center.

### Headlamp washer system\*

Have this system adjusted by your BMW center as required.

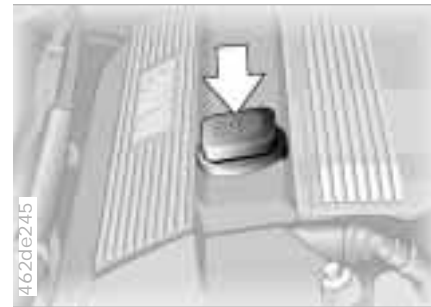
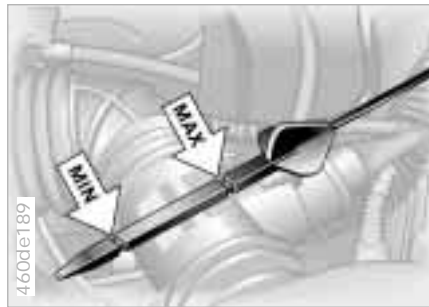

## Checking the oil level

- 1 Park the vehicle on a level surface.
- 2 Shut the engine off after it has reached normal operating temperature.
- 3 After approx. 5 minutes, pull the dipstick out and wipe it off with a clean lint-free cloth, paper towel, or similar material.
- 4 Carefully push the dipstick all the way into the guide tube and pull it out again.
- 5 The oil level should be between the two marks on the dipstick.

As with fuel economy, oil consumption is directly influenced by your driving style and vehicle operating conditions.

The oil volume between the two marks on the dipstick corresponds to approx. 1.1 US quarts (1 liter). Do not fill beyond the upper mark on the dipstick. Excess oil will damage the engine.

## To add oil

Wait until the level has dropped to just above the lower mark before adding oil. However, never let the oil drop below the lower mark.

 BMW engines are designed to operate without oil additives; the use of additives could lead to damage in some cases. This also applies to the manual transmission, automatic transmission, differential and power steering system. ◀

**Specified engine oil**

The quality of the engine oil is extremely important for the function and life of an engine. Based on extensive testing, BMW has approved only certain types of engine oils.

Use only approved "BMW High Performance Synthetic Oil."

If you are unable to obtain "BMW High Performance Synthetic Oil", you may use small volumes of other approved synthetic oils for topping off between oil changes. Use only oils with the specification API SH or higher.

 Ask your BMW center for details concerning the specific "BMW High Performance Synthetic Oil" or synthetic oils that have been approved. ◀

You can also call BMW of North America at 1-800-831-1117 or visit this website: [www.bmwusa.com](http://www.bmwusa.com) to obtain this information.

**Viscosity ratings**

Viscosity is the oil flow rating as established in SAE classes.

The selection of the correct SAE class depends on the climatic conditions in the area where you drive your BMW.

 Approved oils are in SAE classes 5W-40 and 5W-30. ◀

These kinds of oil may be used for driving in all ambient temperatures.

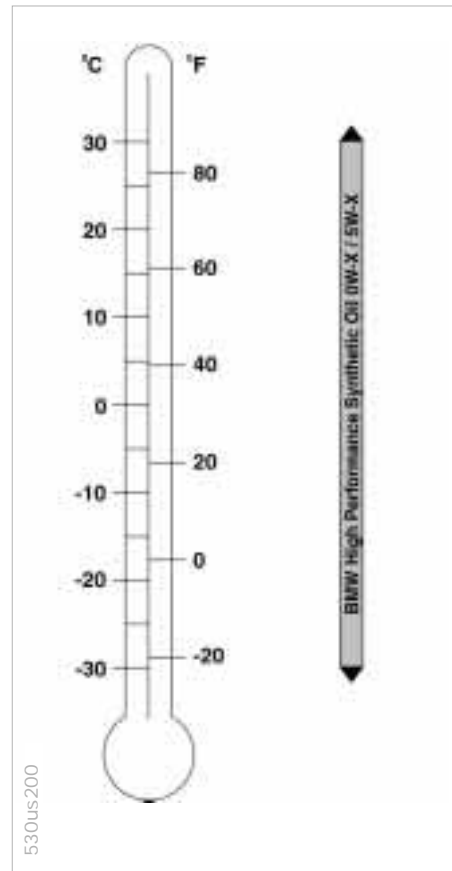





## Engine oil

 Comply with the applicable environmental laws regulating the disposal of used oil. ◀

Recommendation: have the oil changed by your BMW center only.

 Continuous exposure to used oil has caused cancer in laboratory testing. For this reason, thoroughly wash any areas of skin that come into contact with oil using soap and water. Always store oils, grease and similar materials so that they are inaccessible to children. Comply with warning labels and information on containers. ◀

## Coolant

 Do not add coolant to the cooling system when the engine is hot. If you do, escaping coolant can cause burns.

To avoid the possibility of damage later on, never use anything other than factory-approved, nitrite- and amino-free extended-duty antifreeze with corrosion inhibitor. Your BMW center is familiar with the approved specifications.

Antifreeze and anticorrosion agents are hazardous to health. You should always store it in its original container and in a location that is inaccessible to children. Extended-duty antifreeze with corrosion inhibitor contains the flammable substance ethylene glycol. Therefore, do not spill antifreeze with corrosion inhibitor on hot engine parts. It could ignite and cause burns. ◀

 Comply with the applicable environmental laws regulating the disposal of extended-duty antifreeze with corrosion inhibitor. ◀



### Checking coolant level

Correct coolant level when the engine is cold (approx. +68 °F/+20 °C):

Unscrew the cap from the expansion tank.

The coolant level is correct when the upper end of the red float is at least even with the upper edge of the filler neck (refer to the arrow in the illustration), but no more than 0.8 in (2 cm) above it – that is, up to the second mark on the float (refer also the schematic diagram next to the filler neck).

**Adding coolant**

Wait until the engine cools before removing the cap from the expansion tank. The needle of the coolant gauge in the instrument cluster must be located in the blue zone. If it is not, there is a danger of scalding.

- 1 Turn the cap slightly counterclockwise in order to allow accumulated pressure to escape, then open.
- 2 If the coolant is low, slowly add coolant until the correct level is reached – do not overfill.

The coolant is a mixture of water and extended-duty antifreeze with corrosion inhibitor. Always maintain the prescribed all-season 50:50 mixture ratio for year-round protection against internal corrosion. No other additives are required.

Replace the coolant every four years.

**Brake fluid**

If the brake warning lamp comes on and the parking brake has been released:

Check the brake fluid level. Fill it to the top mark ("MAX") if necessary.

For adding brake fluid or for determining and correcting the cause of brake fluid loss, consult your BMW center. Your BMW center is familiar with the specifications for factory-approved brake fluids (DOT 4).

Brake fluid loss can result in extended pedal travel. Comply with the information provided on page [120](#).



Brake fluid is hygroscopic, that is, it absorbs moisture from the air over time.

In order to ensure the safety and reliability of the brake system, have the brake fluid changed every two years by a BMW center. Refer also to the Service and Warranty Information Booklet (US models) or the Warranty and Service Guide Booklet (Canadian models).

Brake fluid is toxic and damages the vehicle's paint. You should always store it in its original container and in a location inaccessible to children.

Do not spill the fluid and do not fill the brake fluid reservoir beyond the "MAX" mark. The brake fluid could ignite upon contact with hot engine parts and cause serious burns. ◀



Comply with the applicable environmental laws regulating the disposal of brake fluid. ◀



In the engine compartment, on the right-hand strut dome (arrow).



The BMW Maintenance System has been designed as a reliable means for providing maximum driving and operating safety – and as cost effectively as possible for you.

Please keep in mind that regular maintenance is not only necessary for the safety of your vehicle, but also plays a significant role in maintaining the resale value of the vehicle.

### **Service Interval Display**

Advanced technology is employed to calculate the optimal maintenance intervals. These are then indicated in the Service Interval Display. While conventional systems rely on distance traveled alone to determine when service is due, the BMW Maintenance System has for years considered the

actual conditions under which the vehicle operates, because miles can be traveled in many different ways:

From a maintenance perspective, 62,000 miles (100,000 km) of short-distance urban driving are not equivalent to 62,000 miles (100,000 km) covered at moderate speeds in long-distance highway travel.

The BMW Maintenance System includes the Engine Oil Service and Inspections I and II.

Determining the maintenance intervals according to the actual use of the vehicle covers every kind of operating situation. However, even those who drive only short distances – significantly less than 6,000 miles (10,000 km) annually – should have the engine oil changed at least every 2 years since oil deteriorates over time, regardless of use.

### **Service and Warranty Information Booklet (US models)/Warranty and Service Guide (Canada models)**

For additional information on maintenance intervals and procedures, please refer to the Service and Warranty Information Booklet (US models) or to the Warranty and Service Guide (Canadian models).

As a precaution against rust, it is advisable to have the body checked for damage from rocks or gravel at the same time, depending upon operating conditions.



Have your BMW center perform maintenance and repair.

Your BMW center is always "up to date" on the latest maintenance work and repair techniques and equipped with the required special tools. In addition, checking parts known from experience to be subject to wear is a permanent part of the maintenance specifications. Be sure that all maintenance work is confirmed in the Service and Warranty Information Booklet (US models) or the Warranty and Service Guide (Canadian models). These entries will constitute your proof that the vehicle has received regular maintenance. They are also required for warranty claims. ◀

## Caring for your vehicle

### Washing your vehicle

You can wash your BMW at an automatic car wash, even when it is new. Brushless systems are preferable.

Wipe away tough dirt and loosen and remove dead insects before washing the vehicle.

In order to avoid spots, do not wash the vehicle when the hood is warm, or during or immediately after exposure to strong sunlight.

When using an automatic car wash, be sure that:

- ▷ The car wash system is suited for the dimensions of your vehicle.
- ▷ No damage will occur to vehicles with attached body accessories (such as spoilers or antennas). Consult the car wash operator if necessary.
- ▷ The wheels and tires of your vehicle cannot be damaged by the conveyance devices of the car wash system.
- ▷ The vehicle is cleaned with minimum brush pressure, and that ample water is available for washing and rinsing.

Vehicles with rain sensor:

Clean the windshield regularly. Wax from automatic car washes or insects can cause malfunctions in the function of the rain sensor.



Turn the rain sensor off (refer to page 69) when passing through an automatic car wash. Failure to do so could result in damage caused by unintended wiper activation. ◀

Parts of the vehicle which are inaccessible to the automatic washer – such as door sills, door and hood edges, etc. – should be cleaned by hand.

In the winter months, it is especially important to ensure that the vehicle is washed on a regular basis. Large quantities of dirt and road salt are difficult to remove, and they also damage the vehicle.



If spray wands or high-pressure washers are used, be sure to maintain an adequate distance between the spray source and the vehicle's surface. Inadequate distance and excessive pressure can damage or weaken the finish, making it more susceptible to subsequent attack. In addition, moisture could penetrate to vehicle components, leading to long-term damage. ◀



When cleaning the headlamps, please observe the following: do not clean by wiping with a dry cloth (scratches). Never use abrasives or strong solvents to clean the covers. Remove dirt and contamination (such as insects) by soaking with BMW Car Shampoo and then rinsing with plenty of water. Always use a deicer spray to remove accumulated ice and snow – never use a scraper. ◀



After washing the vehicle, apply the brakes briefly to dry them. Braking efficiency might otherwise be reduced by the moisture and the brake rotors could be corrode. ◀

### **Exterior finish**

To provide effective corrosion protection, multilayer paintwork is applied at the factory. Cathaphoretic immersion priming techniques are supplemented with special body-cavity protectants, by applying specially-developed and extensively tested materials.

A layer of flexible PVC is first applied to the undercarriage. Following this, a comprehensive undercoating treatment with a wax-based protectant is applied. Regular maintenance makes an important contribution to maintaining the safety and value of your vehicle.

Increasing awareness of the effects of harmful environmental factors on vehicle finishes have led paint and vehicle manufacturers to initiate programs designed to further improve the durability of their finishes. Despite this, environmental factors that occur locally or regionally can have negative effects on the finish of your vehicle. Use the factors to determine the frequency and extent of your efforts to maintain the vehicle finish.

Depending upon material and type of impact (perforation of paint layer), physical stresses from sand, road salt, gravel, etc., can cause corrosion to start extending beneath the finish, starting at the point of impact.

Road dirt, tar spots, dead insects, animal droppings (strong alkali effect) and tree excretions (resins and pollen) all contain substances capable of causing damage when allowed to remain on the finish of your vehicle for any extended period of time (spots, etching, flaking, separation in the top coat).

In industrial areas, flue dust deposits, lime, oily soot, precipitation containing sulfur-dioxide (acid rain) and other environmental pollutants will damage the vehicle's finish unless adequate care is provided – even though this is generally limited to the outside horizontal surfaces.

In coastal regions, high levels of atmospheric salt and humidity promote corrosion.

In tropical zones, temperatures of over +105 °F (+40 °C) in the shade prevail, in addition to heavy ultraviolet radiation and high humidity. Under those conditions, light paints can reach temperatures up to +175 °F (+80 °C) and dark paints up to +250 °F (+120 °C).

# Caring for your vehicle

## Caring for the vehicle finish

Regular washing is a preventive measure against long-term effects from substances that are harmful to the vehicle's finish, especially if you drive your vehicle in areas with high levels of air pollution or aggressive natural substances (tree resins, pollen).

Nevertheless, you should immediately remove especially aggressive substances. Failure to do so can lead to changes in the paint's chemical structure or to discoloration. Gasoline spilled during refueling, oil, grease and brake fluid should always be cleaned away immediately, as should bird droppings.

Any contamination remaining on the surface of the vehicle will be especially conspicuous after washing. Use cleaning fluid or alcohol with a clean cloth or cotton pad to remove. Remove tar spots with tar remover. After cleaning, the affected areas should be waxed to ensure continued protection.

 Use the cleaning and car-care products available at your BMW center. ◀

## Waxing your vehicle

Protect the finish using only carnauba or synthetic-based waxes.

The best way to determine when the finish needs to be waxed is by noting when water stops beading on the surface.

You can use a glass cleaner to remove any wax or silicone that may have been left on the windows during waxing.

 Use the cleaning and car-care products available at your BMW center. ◀

## Paint damage

You can touch up small areas of paint damage with a BMW spray paint or a BMW touchup stick.

The paint color code for your car is provided on a sticker located on the righthand side under the hood and on the first page of your Service and Warranty Information Booklet (US models) or Warranty and Service Guide (Canadian models).

Damage caused by flying stones, scratches, etc., must be touched up without delay to prevent rust from forming.

If corrosion has started to form in an area with paint damage, remove all rust and clean the area. Then prime the area with a BMW Primer Stick. Finally, apply the finish coat. Wait a few days, then polish the repaired area. Finish by applying a wax preservative.

More extensive paint damage should be repaired professionally in accordance with the manufacturer's instructions. Your BMW center uses original BMW finish materials in accordance with approved repair procedures.

### **Caring for the windows**

You can use window and glass cleaner to clean inside window surfaces and mirrors without smearing and streaking. Never use polishing pastes or abrasive (quartz) cleansers on mirror lenses.

Clean the wiper blades with soapy water. The wiper blades should be replaced twice a year – before and after winter. This is especially important for vehicles with a rain sensor.



Use only wiper blades approved by BMW. ◀

### **Caring for other vehicle components and materials**

Light-alloy wheels should be treated with alloy wheel cleaner, especially during the winter months. However, do not use aggressive products containing acids, strong alkalis or abrasives. Do not use steam cleaners operating at temperatures above +140 °F (+60 °C). Follow the manufacturer's instructions.

If your vehicle has chrome parts\*, such as the window frames and door handles, be especially careful about cleaning them with plenty of water and possibly a shampoo supplement as well after the roads have been salted. Use a chrome polish for an additional treatment.

Plastic components, vinyl upholstery, headliners, lamp lenses, the clear cover of the instrument cluster and components with a sprayed dull black surface can be cleaned with water and a synthetic cleaner (if necessary). Do not allow moisture to soak through the seats or headliner. Never use solvents such as lacquer thinner, heavy-duty grease remover, fuels, or similar substances.

Rubber components should be cleaned with water only; a rubber treatment or silicone spray may also be applied.

Safety belts should be cleaned with a mild soap and water solution without being removed from the car. Never attempt chemical or dry cleaning, as damage to the belt fabric could result.

After cleaning, never allow the inertia reel to retract the belts until they are completely dry. Dirty safety belts prevent the inertia reel mechanism from retracting the strap properly, and thus constitute a safety hazard.

Heavily soiled floor carpets and mats\* can be cleaned with an interior cleaner. The floor mats can be removed from the vehicle for cleaning.

Use only a damp cloth to clean trim panels made of real wood\* and other parts constructed of real wood\*. Follow up by drying with a soft cloth.



Use the cleaning and car-care products available at your BMW center. ◀



## Caring for your vehicle

### Care of upholstery materials

Depressions in the upholstery that result from everyday use can be brushed smooth by brushing against the nap with a lightly dampened brush.

The tendency of the pile to lie in a particular direction on velour upholstery is not a quality defect, and, just as on home textiles or clothing, cannot be avoided.

Lint on upholstery materials, textile or leather remnants that have been worn into the upholstery may be removed with a lint brush or a Velcro® brush. A cleaning glove is available for especially "stubborn" lint. Stains and fairly large areas of dirt should be cleaned off without delay, using lukewarm water and an interior cleaner, stain remover or appropriate cleaning fluid. Brush the fabric afterwards to restore its appearance.

If the vehicle is to be stored for an extended period, or if it is exposed to intense sunlight, cover all the seats or the windows to prevent fading.



Use the cleaning and car-care products available at your BMW center. ◀

The buildup of an electrostatic charge on the seat covers, particularly if atmospheric humidity is low, can give the occupants an unpleasant electric shock if they touch metal body parts after leaving the vehicle. Although this is not dangerous in any way, it can be avoided by touching a bare or polished metal part of the vehicle while getting out.

### Leather care

The leather\* upholstery used by BMW is a natural product of the highest quality, processed using state-of-the-art methods to ensure that it will maintain its high quality for years to come, provided that it is properly cared for.

Because this product is manufactured using natural materials, you must make allowance for its special characteristics and for the peculiarities of its use and care.

Regular periodic cleaning and care are essential, as dust and road dirt act as abrasives in the pores and creases of the material. This leads to wear spots and premature brittleness on the surface of the leather. We therefore suggest that you clean the leather with a vacuum cleaner or cloth at frequent intervals.

For cleaning, use BMW leather cleaning foam.

Since dirt and grease gradually attack the protective layer of the leather, the cleaned surfaces should be treated with BMW leather care agent. This also acts as an antistatic agent.

For protection against dampness or moisture, treat the leather with an impregnating agent made by BMW.

## 146 Caring for your vehicle

We recommend that you perform this procedure twice a year on leather exposed to normal use.

Spills should be wiped up immediately. Remove grease and oil stains by dabbing with with spot remover. Avoid rubbing.

If the upholstery is to be exposed to intense sunlight or if the vehicle is to be stored for an extended period, cover all leather surfaces (or, better yet, the windows) to prevent fading.



Use the cleaning and car-care products available at your BMW center. ◀



Cleaning agents can contain substances that are dangerous or pose health risks. Therefore, always comply with the warnings and danger labels on the package.

Open the doors or windows on your vehicle when cleaning the interior.

Never clean your vehicle with solvents or other materials not specifically intended for this purpose. ◀

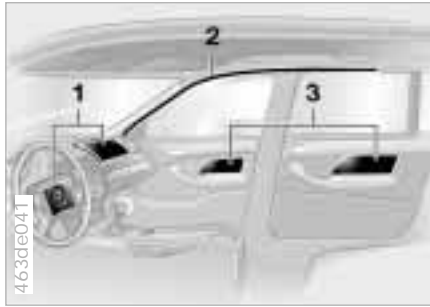

- 1 Front airbags for driver and passenger
- 2 Side Impact Head Protection System for driver and passenger (front)
- 3 Side airbags for driver and passenger (front and rear\*)

### Important safety notices

 Do not remove the airbag restraint system's gas generator. Have testing and service procedures performed by specially qualified technicians only. In the event of a malfunction, deactivation or triggered actuation (as a response to an accident) of the airbag restraint system, consult your BMW center for repairs or service operations.

Modifications may not be made on either the wiring or the individual components in the airbag system. These include the padded steering wheel hub, the instrument panel, the side trim panels of the front or rear doors and the roof pillars or the sides of the headliner. Do not apply adhesive materials to these components, cover or modify them in any way. Do not attempt to remove or dismantle the steering wheel.

To ensure compliance with official safety regulations, entrust disposal of airbag generators to a BMW center. Unprofessional attempts to service the system could lead to failure in an emergency or undesired airbag activation, either of which could result in personal injury. ◀

Consult your BMW center regarding special procedures if you intend to store the vehicle for more than three months.

Any BMW center will be glad to advise you concerning the advisability, legal implications and factory recommendations for technical modifications to the vehicle. For this purpose, the BMW center will require the Vehicle Identification Number and, in some cases, the engine number as well.

### **Light-Emitting Diodes (LEDs)**

Light-emitting diodes installed behind translucent lenses serve as the light source for many of the controls and displays in your vehicle. The concept behind their operation is related to that employed for lasers.



Do not remove the protective lens and avoid staring directly at the unfiltered beam for extended periods (several hours). To do so could result in inflammation of the iris. ◀

California laws require us to state the following warning:



Engine exhaust, some of its constituents, and certain vehicle components contain or emit chemicals known to the State of California to cause cancer and birth defects or other reproductive harm. ◀



The interface socket for onboard diagnostics is located on the driver's side at the left-hand bottom of the dashboard and under a cover. The cover has the letters "OBD" on it.

The purpose of the OBD system is to ensure proper emission control system operation for the vehicle's lifetime by monitoring emission-related components and systems for deterioration and malfunction.



An illuminated indicator informs you of the need for service, not that you need to stop the vehicle. Your system should be checked, however, at the earliest possible opportunity.

If the indicator blinks or flashes, this indicates a high level of engine misfire. Reduce speed and contact your nearest BMW center immediately. Severe engine misfire over even a short period of time can seriously damage emission control components, especially the catalytic converter.



Service Engine Soon warning lamp for Canadian models.



If the fuel filler cap is not properly tightened, the OBD system can detect leaking vapor and the indicator will light up. If the fuel filler cap is then tightened, the indicator will usually go out after a short period of time. ◀



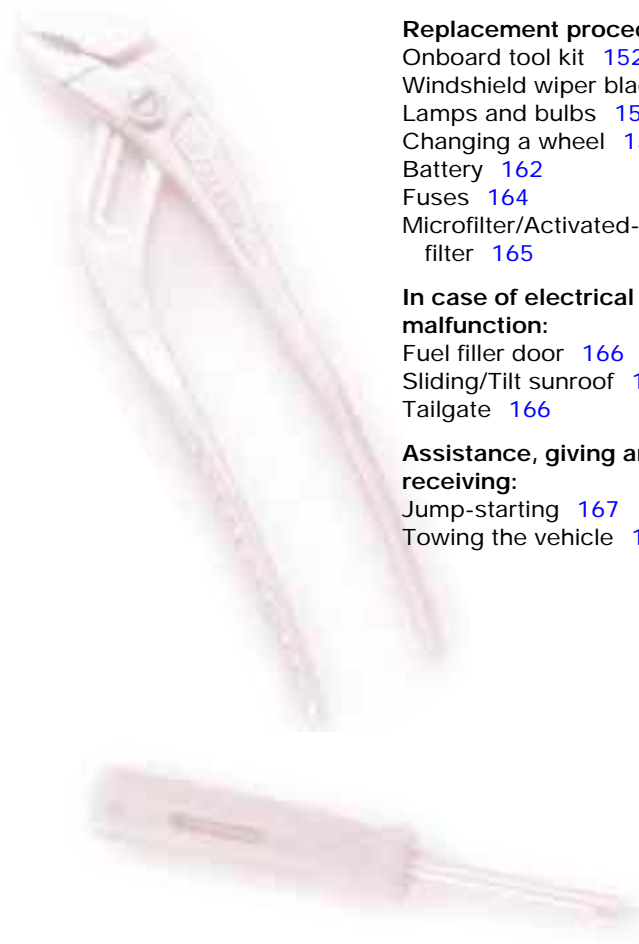

### Replacement procedures:

Onboard tool kit [152](#)  
 Windshield wiper blades [152](#)  
 Lamps and bulbs [153](#)  
 Changing a wheel [159](#)  
 Battery [162](#)  
 Fuses [164](#)  
 Microfilter/Activated-charcoal  
 filter [165](#)

### In case of electrical malfunction:

Fuel filler door [166](#)  
 Sliding/Tilt sunroof [166](#)  
 Tailgate [166](#)

### Assistance, giving and receiving:

Jump-starting [167](#)  
 Towing the vehicle [168](#)

## Overview

## Controls and features

## Operation, care and maintenance

## Owner service procedures

## Advanced technology

## Technical data

## Index



The onboard tool kit is stowed under the cargo area floor panel.

To raise the cargo area floor panel, refer to page [109](#).

## Windshield wiper blades



### Windshield

- 1 Move the wiper to a fold-out position.
- 2 Position the wiper blade at an angle and pull the release spring (arrow).
- 3 Fold the wiper blade down and unhook it toward the windshield.
- 4 Pull the wiper blade past the wiper arm toward the top.
- 5 Insert a new wiper blade and apply pressure until you hear it engage.



Use only BMW approved wiper blades. ◀



### Rear window

- 1 Move the wiper to a fold-out position.
- 2 Remove the wiper blade (arrow).
- 3 Insert a new wiper blade and apply pressure until you hear it engage.



## Lamps and bulbs

The lamps and bulbs are essential factors contributing to the safety of your vehicle. Therefore, comply fully with the following instructions during bulb replacement. If you are not familiar with any of the procedures, consult your BMW center.

 Do not touch the glass portion of a new bulb with your bare hands since even small amounts of impurities burn into the surface and reduce the service life of the bulb. Use a clean cloth, paper napkin, or a similar material, or hold the bulb by its metallic base. ◀

A replacement bulb set is available from your BMW center.

 Whenever working on the electrical system, switch off the electrical accessory you are working on or disconnect the cable from the negative terminal of the battery. Failure to do this could result in short circuits. To prevent injuries and damage, comply with any instructions provided by the bulb manufacturer. ◀



The illustration shows the left-hand side of the engine compartment.

### 1 Low beams

H7 bulb, 55 watts

### 2 High beams

H7 bulb, 55 watts

 The H7 bulb is pressurized. Therefore, wear safety glasses and protective gloves. Failure to comply with this precaution could lead to injury if the bulb is accidentally damaged during replacement. ◀

- 1 Press the two locks at the front and turn left to release the bulb holder.
- 2 Remove and replace the bulb.

 When cleaning the headlamps, please observe the following: do not clean by wiping with a dry cloth (scratches). Never use abrasives or strong solvents to clean the covers. Remove dirt and contamination (such as insects) by soaking with BMW Car Shampoo and then rinsing with plenty of water. Always use a deicer spray to remove accumulated ice and snow – never use a scraper. ◀

### **Xenon lamps\***

The service life of these bulbs is very long and the probability of a failure is very low, provided that they are not switched on and off an unusual number of times. If one of these bulbs should nevertheless fail, it is possible to continue driving with great caution using the fog lamps, provided traffic laws in your area do not prohibit this.

 Because of the extremely high voltages involved, any work on the xenon lighting system and bulb replacement should be performed only by technicians with the appropriate qualifications. Failure to comply with this creates a risk of fatal injury. ◀



The illustration shows the left-hand side of the engine compartment.

### **Parking lamps**

5 watt bulb

- 1 Turn the bulb holder to the left (arrow) and remove it.
- 2 Remove and replace the bulb.



### **Front turn signal indicator**

21 watt bulb

- 1 Using a screwdriver, release the inner hook through the upper opening.
- 2 Remove the lamp by pulling it toward the front.
- 3 Applying light pressure, turn the bulb to the left. Remove and exchange the bulb.



- 4 Insert the 2 pins on the lamp into the guides on the vehicle.
- 5 Push the lamp in. Carefully apply pressure until you hear it engage.

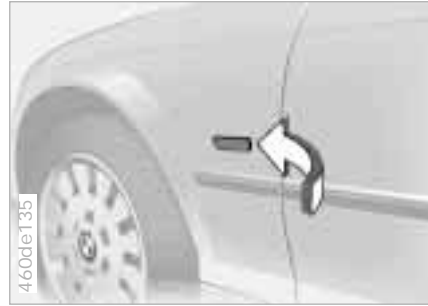

## Side turn signal indicator

5 watt bulb

- 1 Use finger pressure against the rear end of the lens (arrow) to press it forward for removal.
- 2 Apply gentle pressure to the bulb while turning it to the left to remove.



## Front fog lamps\*

HB4 bulb, 55 watts

 The bulb is pressurized. Therefore, wear safety glasses and protective gloves. Failure to comply with this precaution could lead to injury if the bulb is accidentally damaged during replacement. ◀

- 1 Using a screwdriver, carefully remove the lamp.
- 2 Applying light pressure, turn the bulb to the left. Remove and exchange the bulb.



### Tail lamps

Tail lamp 4: bulbs 21/4 watts  
 Remaining bulbs: 21 watts

- |                          |        |
|--------------------------|--------|
| 1 Turn signal indicators | yellow |
| 2 Backup lamps           | white  |
| 3 Tail lamps             | red    |
| 4 Tail lamps/brake lamps | red    |



The illustration shows the right-hand luggage compartment section.

Bulbs in the fender:

All of the bulbs are integrated in a central bulb holder.

- 1 Release and remove the flap from the respective luggage compartment side facing.
- 2 Release the bulb holder (arrow) and remove.
- 3 Pull the power supply receptacle off and set the bulb holder aside (e.g. on the luggage compartment floor).
- 4 Applying light pressure, turn the bulb to the left. Remove and exchange the bulb.
- 5 Plug in the power supply receptacle.
- 6 Press the bulb holder into position until you hear it engage.



Lamps in the tailgate:

- 1 Place a screwdriver in the slot and press downward (arrow) to release.



- 2 Rotate the trim downward. Release the bulb holder and remove it.
- 3 Applying light pressure, turn the bulb to the left. Remove and exchange the bulb.
- 4 Press the bulb holder into position until you hear it engage.
- 5 Press the trim into position until you hear it engage.

## Center (high-mount) brake lamp

LED strip on the rear window.

Please contact a BMW center in the event of a malfunction.

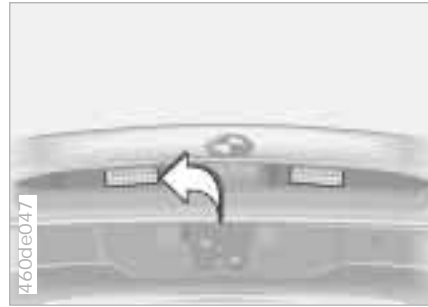

## License plate lamps

5 watt bulb

- 1 Place a screwdriver in the slot and press toward the left (arrow) to release the lens.
- 2 Replace the bulb.



## Tailgate lamp

5 watt bulb

- 1 Remove lamp socket (arrow).
- 2 Replace the bulb.



### **Interior lamps**

The illustration provides an example of the interior lamps when equipped with reading lamps.

Interior lamps (2 x 5 watt bulbs)

- 1 Using a screwdriver, press the lamp out toward the front.
- 2 Remove the lens and pull the bulb out of the contact studs.

Interior lamps (6 watt bulb) with reading lamps\* (2 x 6 watt bulbs)

- 1 Using a screwdriver, press the lamp out toward the front.
- 2 Turn the bulb holder to the left and remove it.
- 3 Remove and replace the bulb.



### **Footwell lamps\***

5 watt bulb

- 1 Press the lamp out using a screwdriver.
- 2 Replace the bulb.

### **Glove compartment lamp**

5 watt bulb

- 1 Press the lamp out using a screwdriver.
- 2 Replace the bulb.

### **Lighted vanity mirrors\***

10 watt bulb

- 1 Remove the bulb housing – use a screwdriver if necessary.
- 2 Replace the bulb.

### **Luggage compartment lamps**

One lamp each in rear tailgate section:  
10 watt bulbs

- 1 Apply a screwdriver to the recess and remove the lens.
- 2 Replace the bulb.

## Changing a wheel

 Take these precautionary measures if you have either a flat tire or are changing a wheel.

Stop the vehicle as far as possible from passing traffic. Park on a firm, flat surface. Switch on the hazard warning flashers. Turn the steering wheel to the straight-ahead position, remove the key and engage the steering lock. Shift into 1st gear or reverse (selector lever in "Park" with automatic transmission) and engage the parking brake.

All passengers should be outside the vehicle and well away from your immediate working area (behind a guardrail, for instance).

If a warning triangle or portable hazard warning lamp is available, set it up on the roadside at an appropriate distance from the rear of the vehicle. Comply with all safety guidelines and regulations.

Change the wheel only on a level, firm surface that is not slippery. Avoid jacking the vehicle on a soft or slippery support surface (snow, ice, loose gravel, etc.), as it could slide sideways.

Position the jack on a firm support surface.

Do not place wooden blocks or similar objects under the jack, otherwise, the jack might not be able to reach its full support capacity because of the limited height.

Do not lie under the vehicle or start the engine when the vehicle is supported by the jack. Failure to comply with this creates a risk of fatal injury. ◀

Your BMW has either a spare tire or space-saver tire for temporary use to ensure your mobility.

 To remove the spare wheel, lift out the floor panel in the luggage compartment completely (refer to page 109). ◀



### What you will need

In order to avoid rattling noises later, note the position of the tools when you remove them and return them to their original position when you are through using them.

#### ▷ Jack (1)

Raise both the floor panel and spare tire panel and loosen the red wing nut (arrow).

When you have completed your work, screw the jack all the way back down. Fold the handle back and insert it into its holder

#### ▷ Wedge (2)

Located behind the jack. Loosen the wing nut to remove it

#### ▷ Wheel stud wrench (3)

## 160 Changing a wheel



- ▷ Spare tire or space-saver tire  
Located next to the jack.  
Loosen the wing nut (arrow) by hand, remove the storage tray and take out the wheel.

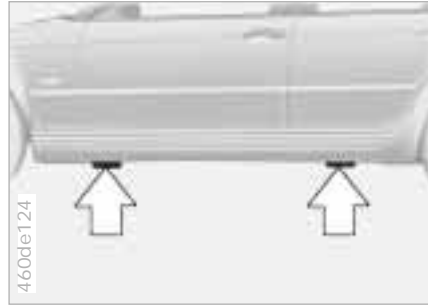

### Procedure

- 1 Read and comply with the safety precautions provided on the previous page.
- 2 Secure the vehicle against rolling: Place the wedge against the rear surface of the front tire on the side opposite the side being raised. If the vehicle is parked on a downward slope, place the wedge securely in front of the tire. If the wheel must be changed on a surface with a more severe slope, take additional precautions to secure the vehicle against rolling.
- 3 If your wheels are equipped with full wheel covers\*: reach into the ventilation openings and pull the cover off.

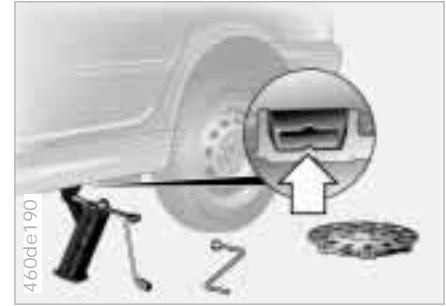

- 4 Loosen the lug bolts 1/2 turn.
- 5 Position the jack under the jacking point nearest the wheel you are changing (refer to the illustration at the left) so that the base of the jack is positioned vertically under the jacking point relative to the entire surface, and that the jack head fits securely into the square recess for the jacking point (refer to illustration detail) when the jack is cranked.
- 6 Jack the vehicle up until the wheel you are changing is raised from the ground.
- 7 Unscrew the lug bolts and remove the wheel.





- 8 Remove mud or dirt accumulation from the mounting surfaces of the wheel and hub. Clean the lug bolts.
- 9 Position the new wheel or the space-saver tire on the hub and screw at least two lug bolts finger-tight into opposite bolt holes.
- 10 Screw in the remaining lug bolts. Tighten all the bolts snugly.
- 11 Lower the jack and remove it from beneath the vehicle.
- 12 Tighten the lug bolts in a diagonal pattern.
- 13 If your wheels are equipped with full wheel covers\*, place the wheel cover with the valve opening over the valve (arrow). Use both hands to press the cover securely onto the rim.

- 14 Check and correct the tire's inflation pressure at the earliest possibility. For vehicles with Tire Pressure Control (RDC): After mounting the spare tire or correcting the inflation pressure, reactivate the system. Refer to page 85.

 Use only the full wheel cover installed by the factory. Other wheel covers may not fit securely. The full wheel cover may not be installed on the space-saver tire since this could damage the cover. ◀

 The vehicle jack is designed for changing wheels only. Do not attempt to raise another vehicle model with it or to raise any load of any kind. To do so could cause accidents and personal injury. To ensure continued safety, have the tightness of the lug bolts [torque specification: 76 lb. ft. (100 Nm)] checked with a calibrated torque wrench. ◀

When storing the wheel, take care to ensure that you do not damage the retaining pin in the spare tire recess.

If light-alloy wheels other than original BMW light-alloy wheels have been mounted, it may be necessary to use different lug bolts for those wheels. Replace the defective tire as soon as possible and have the new wheel/tire balanced.

**Driving with the space-saver tire**

Drive cautiously. Do not exceed a speed of 50 mph (80 km/h).

You can anticipate changes in vehicle handling such as delayed braking response, longer braking distances and changes in self-steering properties in marginal stability limits.

The changes in handling characteristics will be even more pronounced in conjunction with winter tires.

 Only one space-saver tire may be mounted at one time. Reinstall wheels and tires of the same size and specification as soon as possible. Maintain correct tire pressures. Refer to page 29. ◀

**Battery****Installation location**

The battery is in the right rear of the luggage compartment. Release side trim panel and remove. Fold back the cover panel.

 Battery posts, terminals, and related accessories contain lead and lead compounds. Wash hands after handling. ◀

**Charge condition**

You can read the charge condition of the battery with the "Magic Eye\*" (= a hydrometer):

- ▷ Green: adequate charge.
- ▷ Black: not charged adequately. The battery must be recharged. Please contact your BMW center for additional information.
- ▷ Yellow: replace the battery.

 The service life specified for the battery can be achieved only if it is always kept adequately charged. If the vehicle is primarily used for stop-and-go traffic, be sure to check the charge status often. ◀

# Battery

## Battery care

The battery is completely maintenance-free. That means that the original acid will normally last for the service life of the battery under temperate climatic conditions.

 For all questions that regard the battery, please consult your BMW center. Since the battery is absolutely maintenance-free, the following is for your information only. ◀

## Symbols

You will find the following symbols on your vehicle battery. For your safety, please be cautious whenever you work with or near the battery.



Before handling the battery, please read the following information.



Wear eye protection. Do not allow particles containing battery acid or lead to come into contact with your eyes, your skin, or your clothing.



Battery acid is extremely corrosive. Wear eye protection and protective gloves. Do not tip the battery. Battery acid can leak from the ventilation openings.



Do not allow children to have access to batteries and battery acid.



Never allow sparks or open flame near the battery. Do not smoke in the vicinity of the battery. Avoid sparks from electrical cables or electrical equipment. Turn the key to position 0 in the steering lock when disconnecting or connecting the battery. Never short-circuit the battery terminals. This creates a risk of injury from high-energy sparks.



A highly explosive gas is generated when the battery is charged.



If you happen to get acid in your eyes, rinse thoroughly for 15 minutes with clear water. Consult a physician immediately. If you get acid spray on your skin or clothing, rinse with plenty of water. If acid is accidentally swallowed, consult a physician immediately.



In order to protect the battery case from ultraviolet radiation, do not place it in direct sunlight. A discharged battery can freeze. Store the battery in areas where temperature remains above freezing.

## Removal and installation



Do not disconnect the battery while the engine is running. Disconnecting the battery cable when the engine is running will cause a voltage surge which will damage the vehicle's onboard electronics. Do not make any modifications in the wires to the positive terminal. If you do so, the protective function of the safety battery terminal is no longer ensured. Repairs and disposal may only be performed by specially trained personnel. ◀

When removing the battery, disconnect the cable on the negative terminal first, then the cable on the positive terminal. Loosen the center adjusting screw on the battery retaining strap (use the screwdriver included with the onboard tool kit) and disconnect the strap.

When installing a battery, connect the positive terminal first, then connect the negative terminal.



When installing a battery, be sure that it is mounted properly and that the retaining strap is installed using the center adjustment screw, otherwise, the battery will not be secure enough in case of an accident. ◀

**Charging the battery**

Charge the battery in the vehicle only when the engine is not running.

 Before performing any work on the electrical system, disconnect the cable from the negative terminal. If you do not, short circuits can cause fire or personal injury. ◀

If you plan to park the vehicle for longer than 4 weeks, disconnect the battery from the vehicle electrical system by disconnecting the cable at the negative terminal. Then recharge the battery with an appropriate battery charger.

If you intend to store the vehicle for longer than 12 weeks, remove the battery, charge it and store it in a cool and dust-free room where there is no danger of freezing. During storage, have the battery recharged every 3 months. Also recharge the battery before it is reinstalled. If this is not done, the battery will not be serviceable. Every time the battery is drained, especially over extended periods, its service life is reduced.



Return used batteries to a recycling point or your BMW center. Maintain the battery in an upright position for transport and storage. Secure the battery to prevent it from tilting during transport. ◀



Storage periods during which the battery is disconnected are not taken into consideration by the Service Interval Display for changing the brake fluid. For this reason, be sure that the brake fluid is changed every two years, regardless of the information displayed. Read and comply with the information on page 138 covering this subject. ◀

**Fuses**

If an electrical accessory should fail, switch it off and check the fuse.

**In glove compartment**

- 1 Open the glove compartment and turn the two white quick-release fasteners outward. Spare fuses and plastic tweezers are located on the fuse holder.
- 2 Use the plastic tweezers to remove the fuse for the accessory or equipment that has stopped working.
- 3 If the fuse is burned through ("blown"), the metal strip will have melted and separated; replace it with a new fuse of the same ampere rating (color code).

A list of the fuses, their respective ampere ratings and the equipment in their circuits, is provided below the fuse holder.

To close the fuse holder, snap it into position at the top and turn the two fasteners inward.

 Do not attempt to repair a burned-out fuse or replace it with a fuse with a different color or ampere rating. Doing this could cause a fire in the vehicle resulting from a circuit overload. ◀

If the fuse continues to burn out, have the problem corrected by a BMW center.

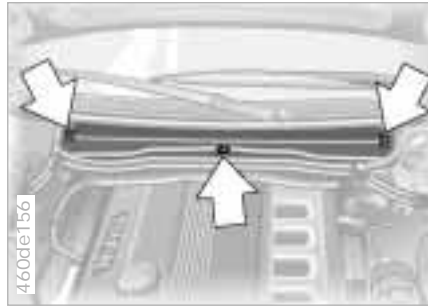

- 1 Open the hood.
- 2 Release the three hooks (arrow) with a  $\frac{1}{4}$  turn.
- 3 Remove the filter cover.

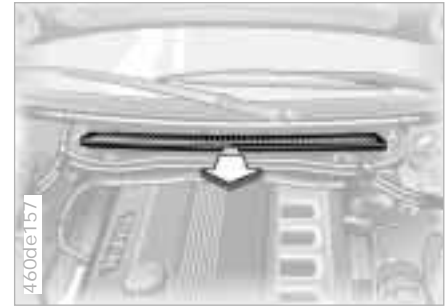

- 4 Remove the filter by pulling toward the front and install a new one.
- 5 Position the filter cover and secure it with the three fasteners.



### Manual release

Unlatch the right-side side panel in the cargo area (arrow 1). Pull the knob with the fuel pump symbol (arrow 2).

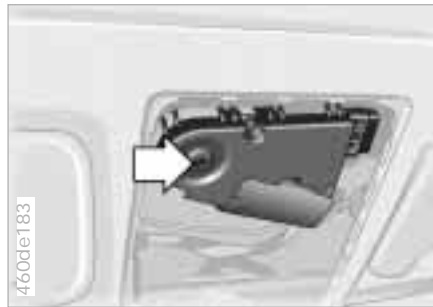

### Manual operation

- 1 Remove the interior lamp (refer to page 158), reach into the opening and push out the panel.
- 2 Turn the sunroof's steel crank with the Allen wrench from the onboard tool kit (refer to page 152) in the desired direction.

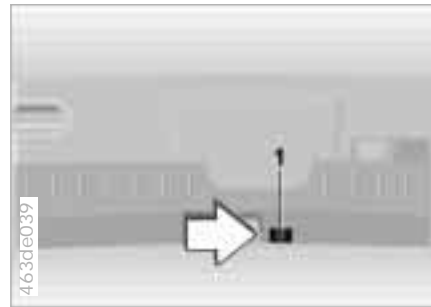

### Manual operation

- 1 Fold either the center armrest or the rear backrest in the back forward.
  - 2 Remove the cover panel under tailgate 1 (possible by using the ignition key).
  - 3 Press the lever (arrow) to the right.
- The luggage compartment is locked again as soon as you close the tailgate.

## Jump-starting

Do not use spray starter fluids to start the engine.

If the battery is drained, the engine can be started using two jumper cables and another vehicle's battery. Use only jumper cables with fully insulated grips on the terminal clamps.

 Do not touch the parts conducting current while the engine is running. Failure to comply with this creates a risk of fatal injury. ◀

Carefully comply with the following instructions to avoid personal injury or damage to one or both vehicles:

- 1 Be sure that the battery on the support vehicle is also rated at 12 volts, and that the capacities of the two batteries (Ah) are roughly comparable (printed on casing)
- 2 Leave the drained battery connected to the vehicle's electrical system
- 3 Make sure that there is no contact between the bodywork of the two vehicles – short circuit risk!
- 4 Start by connecting the jumper cable from the positive terminal of the support vehicle to the positive terminal connector located in your BMW's engine compartment. The



- cover of the auxiliary terminal for jump-starting is identified by a "+" sign. Refer to the illustration. Remove the cover by pulling the tab (arrow 1).
- 5 Then connect the negative terminals. Attach the cable to either the support vehicle's negative battery terminal (-), or to a suitable ground on its engine or bodywork. Then connect the other end of the cable to a ground on the engine or on the bodywork of the vehicle that is to be started. There is a special nut provided for this on the BMW (arrow 2).

 Follow the same sequence for connecting the jumper cables if you assist in jump-starting another vehicle. If you do not, there is a risk of injury caused by spark generation at the battery. ◀

- 6 Start the support vehicle's engine and let it run.
- 7 Start the engine on the vehicle needing the jump-start, and allow it to run as usual. If the first start attempt is not successful, wait a few minutes before another attempt in order to allow the drained battery to recharge.
- 8 Before disconnecting the jumper cables from your BMW, turn on the rear window defroster and set the blower to the highest speed; allow the engine to run approx. 10 seconds. This will prevent a voltage surge from the voltage regulator to the electrical accessories.
- 9 Then disconnect the jumper cables in reverse sequence.

Depending on the reason for the malfunction, recharge the battery.

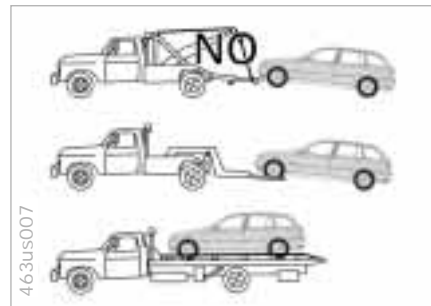

### Tow fitting

The screw-in tow fitting is stored in the onboard tool kit; be sure that it remains in the vehicle at all times. This fitting is designed for installation in the tow sockets located at the front and rear of the vehicle. It is intended for towing on paved road surfaces only. This fitting should not be used to pull a vehicle out of deep snow, mud, sand, etc. Always observe all applicable towing laws and regulations.

### Access to tow socket

Front:

Using a screwdriver, press out the cover panel on the top part of the recess.

Rear:

Using a screwdriver, press out the cover panel on the top part of the recess.



Screw the tow fitting in until it bottoms firmly. If this is not done, the threads could be damaged. Do not tow the vehicle by any components of the running gear, or lash them down in any way. If you do, the components could be damaged, leading to possible accidents. ◀

### Towing with a commercial tow truck

- ▷ Do not tow with sling-type equipment.
- ▷ Use wheel lift or flat bed equipment.
- ▷ Please comply with applicable state towing laws.



Never allow passengers to ride in a towed vehicle for any reason. Never attach tie-down hooks, chains, straps, or tow hooks to tie rods, control arms, or any other part of the vehicle suspension, as severe damage to these components will occur, leading to possible accidents. ◀



## Towing the vehicle

### BMW 325xi: tow the vehicle with one raised axle

- 1 Place the gearshift lever or selector lever in "Neutral."
- 2 Switch off the engine.
- 3 Towing speed:  
Maximum 30 mph (50 km/h).
- 4 Towing distance:  
Maximum 95 miles (150 km).



Remove the rear driveshaft for longer towing distances with the front axle lifted; remove the front driveshaft for towing over longer distances with the rear axle lifted. Failure to comply with this will result in damage to the transfer box. ◀

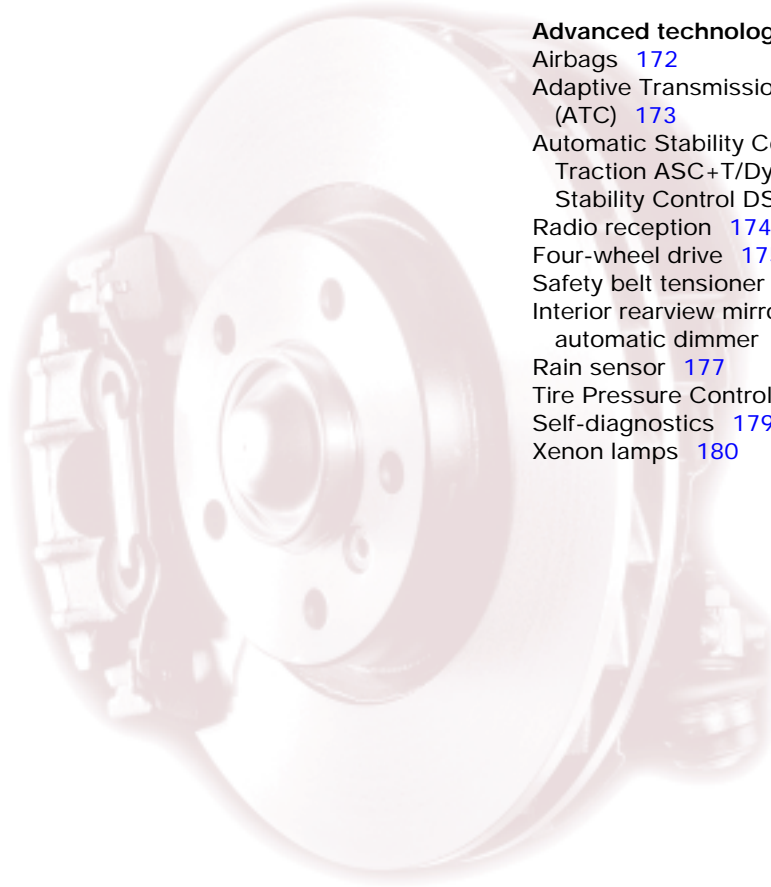

**Advanced technology:**

- Airbags [172](#)
- Adaptive Transmission Control (ATC) [173](#)
- Automatic Stability Control plus Traction ASC+T/Dynamic Stability Control DSC [173](#)
- Radio reception [174](#)
- Four-wheel drive [175](#)
- Safety belt tensioner [175](#)
- Interior rearview mirror with automatic dimmer [176](#)
- Rain sensor [177](#)
- Tire Pressure Control (RDC) [178](#)
- Self-diagnostics [179](#)
- Xenon lamps [180](#)

**Overview****Controls and features****Operation, care and maintenance****Owner service procedures****Advanced technology****Technical data****Index**

## 172 Airbags



Deceleration sensors continuously monitor the acceleration forces acting upon the vehicle. If, as the result of a frontal collision, a deceleration is reached at which the protection of the safety belts alone is no longer adequate, the gas generators of the driver and passenger-front airbags are ignited. However, the passenger-side airbag is only triggered if an additional sensor has recognized that the passenger seat is occupied.

In the event of a side collision, the Head Protection and side airbags in the front or rear\* are triggered if necessary.

The airbags located under the marked covers inflate and unfold in a matter of a few milliseconds. In this process, they tear through the designed separation points of the upholstered covers or press them out.

Because the inflation process must be virtually instantaneous, it is necessarily accompanied by a certain amount of ignition and inflation noise. The gas required to inflate the airbags is not dangerous, and the smoke associated with it dissipates.

The entire process is completed within fractions of a second.



On vehicles with an automatic transmission, the Adaptive Transmission Control (ATC) uses a number of factors to calculate the gear which provides maximum efficiency. In this process, it considers your individual driving style as well as current driving conditions.

ATC recognizes your personal driving style from the positions and movements of the accelerator pedal, deceleration when braking, and lateral acceleration through curves. Based on different shift characteristics – from comfort-oriented to performance-oriented – ATC will select the appropriate gear.

In order to include driving conditions in its calculations, ATC registers curves and both uphill and downhill gradients. For example, if you maintain speed through a curve, the transmission does not shift up. On uphill gradients, it shifts up only when the engine speed increases in order to make more efficient use of power reserves. On downhill gradients, ATC shifts down when the speed of the vehicle increases and the driver must apply the brakes.

Highly sensitive sensors monitor the number of revolutions of the wheels, steering angle, lateral acceleration, brake pressure and the movement of the vehicle around its vertical axis.

If differences in the wheel speeds occur, ASC+T recognizes the danger of wheelspin and reduces torque. If necessary, the system also responds with additional brake applications at the rear wheels.

In addition, DSC permanently monitors the vehicle's current operating condition and compares it with an ideal condition that is calculated from the sensor's signals. If deviations from this occur (understeering or oversteering, for instance), DSC can stabilize the vehicle in fractions of a second by reducing engine output and with the assistance of braking intervention at individual wheels. As a result, dangerous skids can be prevented even as they are just beginning.

You may need some time to become accustomed to this system's intervention. However, it provides optimum drive force and vehicle stability.

The braking intervention may be accompanied by sounds specific to the system.

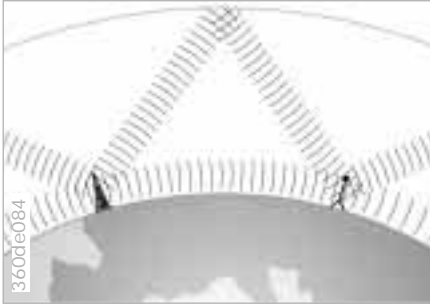

The AM frequency bands (medium-wave, long-wave and short-wave) make it possible to receive stations from a great distance, because the broadcast signals travel not only along the ground as surface waves, but also as atmospheric waves that are reflected from the ionosphere.

Frequency-modulation (FM) provides substantially better sound quality than the other frequencies. However, because FM transmissions rely on line-of-sight broadcast waves, their effective reception range is limited.

The limitations inherent to radio reception in a moving vehicle have been minimized by a number of innovative system designs:

The Radio Data System (RDS) makes sure that, for broadcast stations transmitting on several frequencies, the radio automatically tunes to the frequency with the best reception quality.

The Diversity Antenna system employs several FM antennas integrated within the rear window to provide three separate sources for receiving broadcast waves. An integral processor automatically selects the antenna with the best FM reception quality at any given time. The selection of the antenna takes place within milliseconds, and is therefore not noticed by the radio listener.

## Four-wheel drive

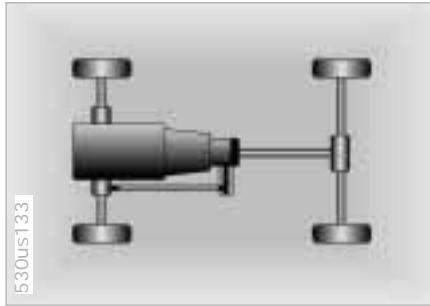

The transmission of power to the four drive wheels is provided permanently through a transfer box. The distribution of torque between the front and rear axles is 38 % to 62 %.

Traditional differential locks at the front and rear axles and in the transfer box are not required. Their function is assumed by automatic braking intervention at all four wheels. These traction interventions are governed by Automatic Differential Brake (ADB-X), a sub-function of DSC.

If a wheel tends to slip, it is braked automatically by ADB-X until it once again gains traction, and drive force can be transmitted to that wheel. In addition, the drive force is distributed to the remaining wheels during this

system intervention. Engine output is also reduced if necessary.

When the DSC is deactivated, the ADB-X traction intervention is set for the maximum drive force. However, the engine intervention and the stability controls are no longer available. For this reason, DSC should only be deactivated in the exceptional circumstances described on page 81.

The BMW 325xi is not an off-road vehicle. Instead, permanent four-wheel drive provides a high degree of vehicle stability and tractive ability under all road conditions, and will aid you in critical driving situations, e.g. driving in extreme winter conditions or on loose road surfaces.

## Safety belt tensioner

175



The safety belt tensioner responds to severe frontal collisions by tightening the belts to ensure that occupants remain firmly positioned in their seats. A gas-pressure system retracts the buckle assembly to tension the shoulder and lap belts within fractions of a second. This reduces the tendency to slide under the lap belt.

## 176 Interior rearview mirror with automatic dimmer\*

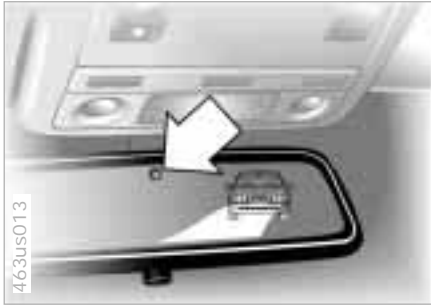

The semisolid reacts chemically to this electrical current, thus providing dimming of the mirror through an infinitely-variable range (electrochromic technology).

As a result, it is no longer necessary to dim the mirror manually, and the driver can concentrate completely on traffic conditions.

The interior rearview mirror with automatic dimming feature reduces blinding from following traffic by adapting the intensity of the reflected images to correspond to levels of light registered by the unit's sensors. The mirror reverts to its undimmed setting as soon as the light source disappears. One light sensor is mounted on the front of the mirror housing. This sensor, the one that is directed forward, measures light intensity in the area ahead of the vehicle. The second sensor is integrated within the mirror's glass. The electronic control system compares the light intensity from front and rear. The difference provides the basic parameter used to modulate an electrical current and induce chemical changes in a semisolid layer incorporated in the lens.



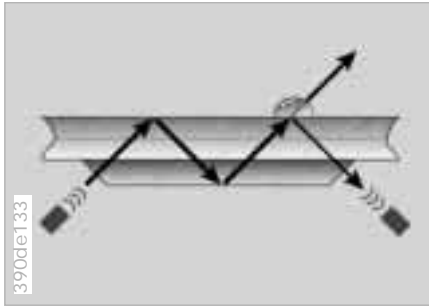

When the system is set to the "Intermittent" wiper speed, the wipers react immediately – if water is splashed onto the windshield by vehicles traveling ahead of you, for example. As a result, the rain sensor contributes to driving safety and comfort.

Depending on how wet the windshield is, the rain sensor controls the operation of the windshield wipers.

Infrared light is carried along the surface of the windshield in an optical conductor in such a manner that it is reflected completely when the windshield is dry. The quantity of reflected light is measured.

If there is moisture on the glass, the amount of light reflected is reduced since the infrared light at the surface of the windshield can escape. The quantity of reflected light is thus a means of gauging the degree of wetness on the windshield.

## 178 Tire Pressure Control (RDC)\*

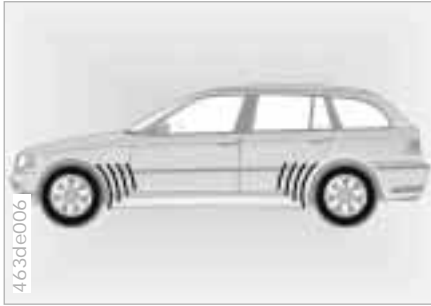

There is an antenna located right near every wheel in the vehicle body. This antenna picks up signals from its respective wheel. A central electronics system evaluates the quadruple signals which it receives and forwards any changes.

The RDC provides an important contribution to driving safety.

This system regularly checks tire pressure and monitors all four tires even while driving, so you do not have to.

Behind the valve stem in every wheel, there is an electronic chip which is designed for severe-duty applications and long service life. It contains a pressure sensor, a transmitter and a battery. The pressure is measured in extremely short time intervals and then transmitted by a radio signal. If an irregularity is detected, the transmission rate is increased.



All of the important electrical and electronic systems in the vehicle are tested regularly and automatically; the driver does not have to perform any extra operations or adjustments.

The indicator lamps also come on briefly after the ignition has been turned on.

While you are driving, the functional status of the actuator motors (for the windshield wipers, power windows, seats, sliding/tilt sunroof, etc.) is constantly analyzed by current measurements in their relays.

In the same manner, the electrical resistance of the airbag ignition generators and all of the remaining airbag components is measured at all times. Any fault in this system would be detected immediately by a current fluctuation that would necessarily accompany it. The fault would be indicated immediately by the airbag warning lamp.

Even after you shut off the engine, the overall functional status of your vehicle is monitored. For example, all of the flaps of the heating and ventilation system travel to the nearest limit position. This action ensures that the system will be able to provide defrosting, regardless of other circumstances, e.g. if a malfunction in the air conditioner/climate control system should occur during the night while the vehicle is parked.

A calibration cycle runs every tenth time the engine is shut off. During this cycle, the actuator motors move all air conditioner/automatic climate control flaps to their limit stops in both directions. The limit positions and the return travel paths are checked in this manner in order to ensure that appropriate adjustments for the operating elements can be made at any time.

You will hear the sounds of the air flaps as the air conditioning system/automatic climate control carry out their self-diagnostic functions after the ignition has been turned off. All of the other self-diagnostics functions operate silently in the background.

Any possible defects detected during these self-diagnostics can be read out by your BMW center and quickly corrected during the vehicle's next regularly scheduled maintenance.

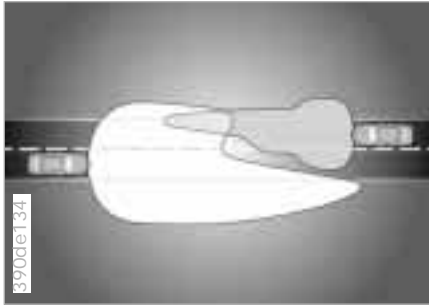

The xenon lamp provides forward illumination with significantly more brightness and uniformity than the traditional halogen lamp.

In a xenon lamp, an electric arc replaces the filament in order to generate intense illumination. A gas mixture in a quartz glass tube with metal vapor is ignited by a high electric voltage. The arc that is generated is then sustained by a lower voltage. When the lamp is turned on, there is a brief warm-up period. Maximum brightness is attained in approx. 15 seconds.

Xenon lamps provide significantly improved visibility, especially during adverse weather and poor driving conditions e.g. driving at night in heavy rain or through road repair areas where there are no lane markers.

Vehicles with xenon lamps are equipped with an automatic headlamp range control. Thus the highway is always optimally lighted and drivers in oncoming traffic are not blinded.

Xenon lamps make a significant contribution to highway safety since other highway users, bicyclists and motorcyclists in the right lane, and pedestrians are more easily detected.



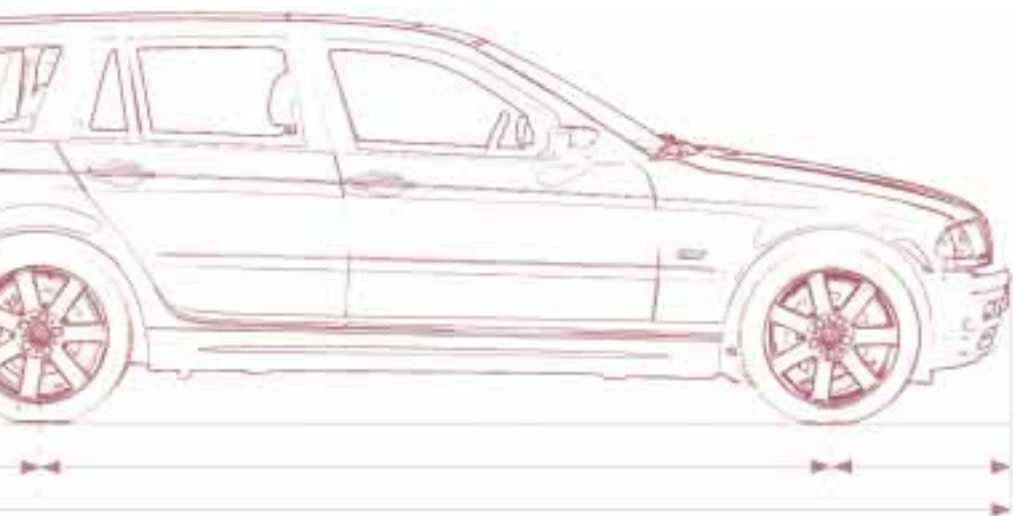

[Engine data 184](#)  
[Dimensions 185](#)  
[Weights 186](#)  
[Capacities 187](#)  
[Electrical system 188](#)  
[Drive belts 188](#)

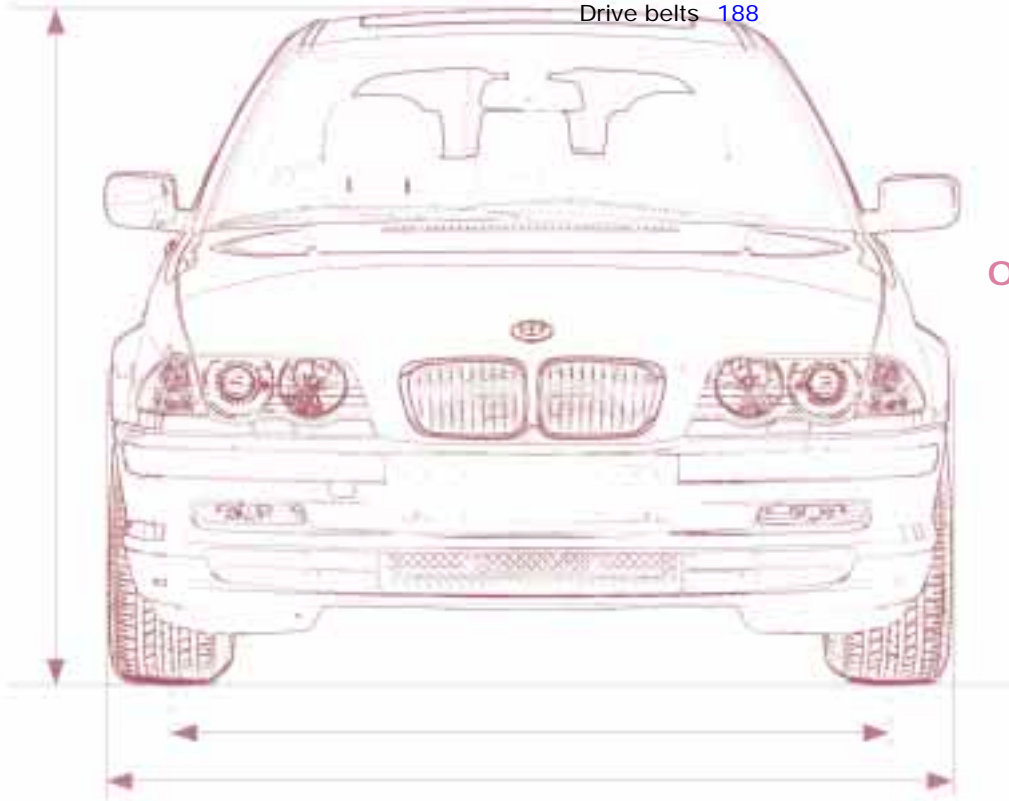

[Overview](#)

[Controls and features](#)

[Operation, care  
and maintenance](#)

[Owner service procedures](#)

[Advanced technology](#)

[Technical data](#)

[Index](#)

Overview

Controls

Car care

Repairs

Technology

Data

Index

184 **Engine data**

		BMW 325i/325xi
Displacement	cu.in (cm <sup>3</sup> )	152.2 (2,494)
Number of cylinders		6
Maximum output at engine speed	hp (kW) rpm	184 (135) 6.000
Maximum torque at engine speed	lb.ft (Nm) rpm	175 (237) 3.500
Compression ratio	$\varepsilon$	10.5
Stroke	in (mm)	2.95 (75)
Bore	in (mm)	3.31 (84)
Fuel-injection system		Digital-electronic engine-management system



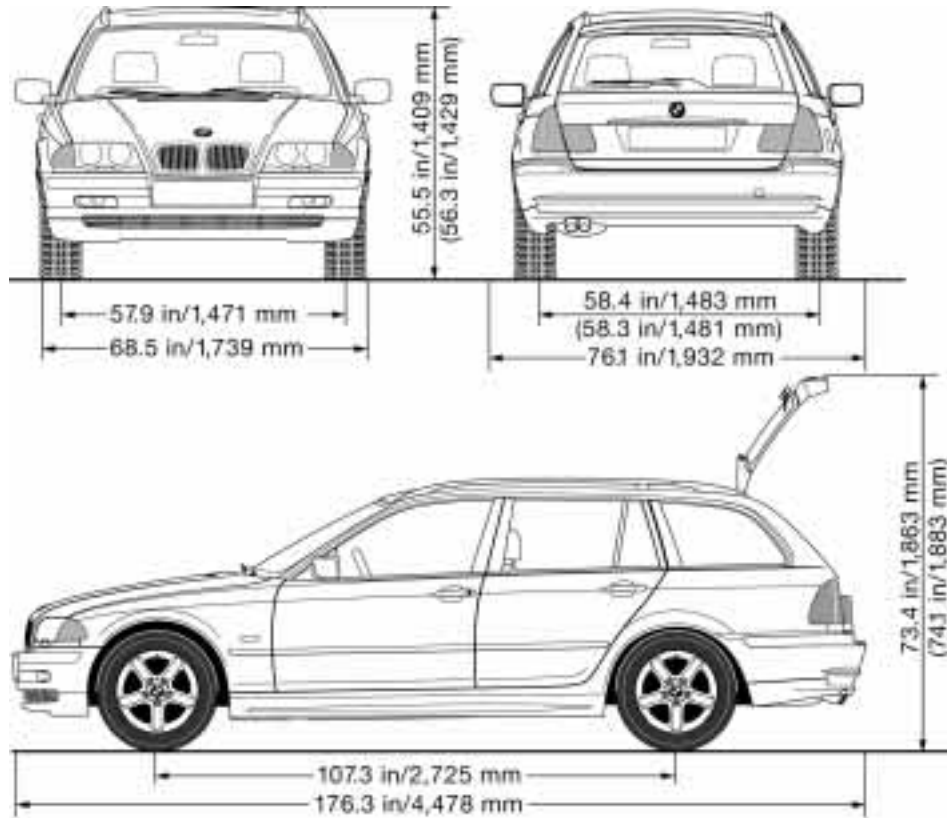

Dimensions in ( ) apply to 325xi.

Height with roof-mounted luggage rack: 56.9 in/1,444 mm (57.6 in/1,464 mm).

Minimum turning circle dia.: 34.4 feet/10.5 m (35.8 feet/10.9 m).

463us015

		BMW 325i	BMW 325xi
Curb weight (with one person, ready for operation, full tank of fuel, options not included)			
with manual transmission	lb. (kg)	3,384 (1,535)	3,627 (1,645)
with automatic transmission	lb. (kg)	3,428 (1,555)	3,693 (1,675)
Approved gross vehicle weight			
with manual transmission	lb. (kg)	4,531 (2,055)	4,729 (2,145)
with automatic transmission	lb. (kg)	4,576 (2,075)	4,795 (2,175)
Approved front axle weight	lb. (kg)	2,006 (910)	2,183 (990)
Approved rear axle weight	lb. (kg)	2,579 (1,170)	2,668 (1,210)
Approved roof load capacity	lb. (kg)	165 (75)	165 (75)
Luggage compartment capacity	cu. ft. (liters)	15.4 - 47.5 (435 - 1,345)	15.4 - 47.5 (435 - 1,345)

Approved axle loads and approved gross vehicle weight may not be exceeded.

			Notes
Fuel tank reserve	gal. (liters) gal. (liters)	approx. 16.6 (approx. 63) approx. 2.1 (approx. 8)	Fuel specification: page <a href="#">28</a>
Windshield washer system/ Headlamp washer system (front) Rear window washer system (rear)	quarts (liters) quarts (liters)	approx. 5.6 (approx. 5.3) approx. 2.4 (approx. 2.3)	For details: page <a href="#">134</a>
Cooling system including heater circuit	quarts (liters)	approx. 8.9 (approx. 8.4)	For details: page <a href="#">137</a>
Engine oil filter change	quarts (liters)	325i approx. 6.9 (approx. 6.5) 325xi: approx. 7.9 (approx. 7.5)	BMW High Performance synthetic oil Specifications: page <a href="#">136</a>
Manual and automatic transmission and differential		-	Lifetime fluid, no fluid change required

## 188 **Electrical system**

### **Battery**

12 V, 80 Ah

### **Spark plugs**

NGK BKR 6 EQUIP

Bosch FGR 7 DQP

## **Drive belts**

Water pump – Generator –

Power steering

Drive belt 6 PK x 1538

A/C compressor

Drive belt 5 PK x 863



You can obtain Original BMW Parts and Accessories, as well as professional advice from your BMW center. ◀



A B C

P Q R

Everything from A to Z 192

Owner service procedures 198

Overview

Controls and features

Operation, care  
and maintenance

Owner service procedures

Advanced technology

Technical data

Index

Overview

Controls

Car care

Repairs

Technology

Data

Index

# Everything from A to Z

## A

ABS (Antilock Brake System) [22](#), [116](#)  
Accessories [6](#)  
Activated-charcoal filter [100](#), [165](#)  
Adaptive Transmission Control (ATC) [65](#), [173](#)  
Adding engine oil [135](#)  
Adding washer fluid [134](#), [187](#)  
Adjust  
backrest [47](#)  
steering wheel [50](#)  
temperature [92](#)  
thigh support area [48](#)  
Air conditioner [90](#)  
Air distribution [92](#), [98](#)  
Air nozzles [90](#)  
Air outlets [96](#)  
ventilation [90](#), [96](#)  
Air pressure [124](#)  
Air supply [92](#), [99](#)  
Airbags [21](#), [58](#), [147](#), [172](#)  
Alarm system [41](#)  
Antenna [123](#)  
Antenna Diversity [174](#)  
Antifreeze [137](#)  
radiator [121](#)  
Antilock Brake System (ABS) [22](#), [116](#)  
Anti-theft alarm system [41](#)  
Aquaplaning [115](#), [124](#)

Armrest [102](#)

ASC+T (Automatic Stability Control plus Traction) [22](#), [173](#)  
Ashtray [104](#)  
ATC (Adaptive Transmission Control) [65](#), [173](#)  
Attaching vacuum cleaner [104](#)  
AUC (Automatic climate control) [96](#)  
Automatic car washes [141](#)  
Automatic climate control [96](#)  
remove condensation from the windows [98](#)  
Automatic cruise control [71](#)  
Automatic dimming, interior rearview mirror [52](#)  
Automatic Stability Control plus Traction (ASC+T) [22](#), [173](#)  
Automatic transmission [21](#)  
Automatic transmission with Steptronic [65](#)  
Automatic washer rear window [69](#)  
windshield [69](#)  
Average consumption [77](#)  
Average speed [77](#)  
Axle loads [186](#)

## B

Backrest, adjusting [47](#)  
Backup lamps [64](#)  
bulb replacement [156](#)  
Battery [162](#), [188](#)  
capacity [188](#)  
charging [164](#)  
discharged [167](#)  
removal and installation [163](#)  
Battery charge current [20](#)  
Battery safety terminal [163](#)  
Belts [53](#)  
Beverage holder [102](#)  
Blower [92](#), [99](#)  
BMW High Performance Synthetic Oils [136](#)  
BMW sports seat [48](#)  
Bore [184](#)  
Brake  
fluid [138](#)  
hydraulic system [20](#)  
pads [22](#)  
Brake lamps  
bulb replacement [156](#)  
Brake system [118](#)  
faults [120](#)  
Break-in procedure [114](#)  
Bulb replacement [153](#)  
Bulbs and lamps [153](#)

## C

California Proposition 65 Warning [148](#)  
Capacities [187](#)  
Car Memory [52](#)  
Car radio [123](#)  
reception [174](#)  
refer also to the separate Owner's Manual  
Car telephone [103](#)  
Car vacuum cleaner, connecting [104](#)  
Car wash [141](#)  
Care  
upholstery [145](#)  
vehicle exterior [142](#)  
vehicle finish [143](#)  
vehicle interior [144](#)  
wool velour [145](#)  
Cargo loading [110](#)  
Catalytic converter [115](#)  
CBC (Cornering Brake Control) [21](#), [117](#)  
Cellular phone [123](#)  
refer to the separate Owner's Manual  
Center armrest [102](#)  
Center (high-mount) brake lamp [157](#)  
Central locking system [34](#)  
button [38](#)  
Changing a tire [159](#)



- Changing a wheel [159](#)
  - Charge indicator lamp [20](#)
  - Check air pressure [28](#)
  - Check Control [75](#)
  - Check engine oil level [135](#)
  - Child restraint systems [54](#), [60](#)
  - Child-safety locks [58](#)
  - Child's seat [54](#)
  - Cigarette lighter [104](#)
  - Cleaning windshield [68](#)
  - Clock [75](#)  
refer also to the Radio or Computer Owner's Manual
  - Cockpit [16](#)
  - Coin holder [102](#)
  - Combination switch [68](#)
  - Compression [184](#)
  - Computer [76](#)
  - Configure settings [52](#)
  - Consumption [77](#)  
display [74](#)
  - Contents [10](#)
  - Control elements [20](#)
  - Coolant [121](#), [137](#), [187](#)  
antifreeze [121](#)
  - Coolant temperature gauge [74](#)
  - Cooling system [187](#)
  - Copyright [4](#)
  - Cornering Brake Control (CBC) [21](#), [117](#)
  - Cruise control [71](#)
  - Cruising range [77](#)
  - Cup holder, refer to beverage holder [102](#)
  - Curb weight [186](#)
  - Current check indicator [20](#)
- D**
- Dashboard [16](#)
  - Data  
dimensions [185](#)  
engine [184](#)  
technical [184](#)  
weights [186](#)
  - Daytime-driving lamp switch [87](#)
  - DBC (Dynamic Brake Control) [118](#)
  - Defrost position [94](#), [98](#)
  - Defrostable rear window [99](#)
  - Defrosting  
rear window [92](#)  
windows [94](#), [98](#)
  - Digital clock [75](#)
  - Dimensions [185](#)
  - Dipstick, engine oil [135](#)
  - Disc brakes [118](#)
  - Displacement [184](#)
  - Display lighting [87](#)
  - Displays [18](#)
  - Distance warning [78](#)
  - Diversity Antenna system [174](#)
  - Door key [32](#), [35](#)
  - Door locks, care [121](#)
  - Doors  
child-safety locks [58](#)  
emergency operation [34](#)  
unlocking and locking [34](#)
  - DOT Quality Grades [125](#)
  - Draft-free ventilation [93](#)
  - Drive belts [188](#)
  - Driving hints [115](#)
  - Driving in winter [121](#)
  - Driving lamps [87](#)
  - DSC (Dynamic Stability Control) [81](#), [173](#)
  - Dynamic Brake Control (DBC) [118](#)
  - Dynamic Stability Control (DSC) [22](#), [81](#), [173](#)
- E**
- Electric power seat [48](#)
  - Electric power windows [43](#)
  - Electrical accessories, failure [164](#)
  - Electrical system [188](#)
  - Electronic vehicle immobilizer [33](#)
  - Elements of operation [16](#)
  - Emergency operation, doors [34](#)
  - Energy Control [73](#)
  - Engine  
coolant [137](#), [187](#)  
data [184](#)  
starting [61](#)
  - Engine oil  
capacity [187](#)  
consumption [135](#)  
pressure [20](#)  
quality [136](#)  
specifications [136](#)  
viscosity [136](#)
  - Engine speed [184](#)
  - Exterior mirrors [51](#)
- F**
- Failure messages [75](#)
  - Fault displays [75](#)
  - Fault, ABS [117](#)
  - Filler cap cover [27](#)
  - Filling capacities [187](#)
  - Filling the washer reservoir [187](#)
  - First-aid kit [26](#)
  - Fittings, tow starting and towing [168](#)
  - Flashlight [101](#)
  - Flat tire [124](#), [159](#)
  - Fog lamps [88](#)

# Everything from A to Z

Folding rear backrest 108  
Footbrake 118  
Footwell lamps 88  
    bulb replacement 158  
Four-wheel drive 175  
Front fog lamps, bulb  
    replacement 155  
Front seat adjustment 46  
Frost protection,  
    radiator 137  
Fuel 28  
    consumption 77  
    consumption display 74  
    gauge 74  
    preparation 184  
    quality 28  
Fuel filler door  
    releasing following an  
    electrical malfunction 166  
Fuel reserve indicator  
    lamp 74  
Fuel tank capacity 187  
Fuel tank gauge 74  
Functional status 179  
Fuses 164

## G

Gasoline 28  
Gasoline gauge 74  
Gasoline quality 28  
Glove compartment 101

Glove compartment lamp,  
    bulb replacement 158  
Gross vehicle weight 186

## H

Handbrake 63  
Hands-free system 103  
Hazard warning flashers 26  
Hazard warning triangle 26  
Head restraint 47  
Headlamp covers,  
    care 141, 153  
Headlamp flasher 88  
Headlamp washer  
    system 70, 134, 187  
Heated seats 100  
Heating, rapid 94  
Heavy loads 110  
Height 185  
HiFi system 101  
High beams 23, 68, 88  
    bulb replacement 153  
High Performance Synthetic  
    Oils 136  
High-mount brake lamp 157  
Hood release 130  
Horn 17  
Hubcap 160  
Hydraulic Brake assistant,  
    refer to DBC 118

## I

Ice warning 76  
Icy roads 76, 121  
Identification, tires 127  
Ignition key 32, 35  
Ignition lock 61  
Imprint 4  
Indicator lamps 20  
Inflation pressure 28, 124  
    monitoring 85, 178  
INSPECTION 74  
Installation child restraint  
    systems 60  
Instrument cluster 18  
Instrument lighting 87  
Interaxle tire rotation 126  
Interface socket for Onboard  
    Diagnostics 149  
Interference, cellular  
    phone 123  
Interior lamps 36, 88  
    bulb replacement 158  
    remote control 36  
Interior motion sensor 41  
Interior rearview mirror 51  
    automatic dimming  
    feature 52, 176  
Interlock 61  
Intermittent wipe 68

## J

Jack 159  
Jump-starting 167

## K

Key 32, 35  
Key Memory 52

## L

Lamps and bulbs 153  
Lashing eyes 110  
LATCH attachment of the  
    child seat 58  
Leather care 145  
Length 185  
License plate lamp  
    bulb replacement 157  
Light switch 87  
Light-alloy wheels 129  
Lighter 104  
Load-securing devices 110  
Louvers 90, 96  
Low beam headlamps 87  
    bulb replacement 153  
Lug bolts 160  
Lug wrench 159

## Luggage

- compartment 38, 107
- capacity 186
- emergency release 166
- lamps 39
- lamps, bulb
- replacement 158
- remote control system 37
- trunk floor 40

- Luggage compartment lid
- emergency release 166

- Luggage rack 111

- Lumbar support 48

## M

- Maintenance 74
- Malfunction displays 75
- Manual transmission 64
- Memory 49
- MFL (Multifunction steering wheel) 24
- Microfilter 93, 165
- Mirror memory 49
- Mirrors 51
- Mobile phone 123
- Modifications, technical 6, 148
- Motion sensor, interior 41
- Multifunction steering wheel (MFL) 24
- M+S tires 128

## N

- Neckrest 47
- Nozzles 96

## O

- OBD interface socket 149
- Obstruction protection 43
- Odometer 73
- Oil

- additives 135
- capacity 187
- consumption 135
- dipstick 135
- quality 136
- specifications 136
- viscosity 136

- Oil change intervals, refer to the Service and Warranty Information Booklet or to the Warranty and Service Guide Booklet

- Oil filter change 187
- Oil level, indicator lamp 20
- Oil pressure, indicator lamp 20
- OILSERVICE 74

- Onboard computer, please refer to Computer 76

- Onboard tool kit 152

- Opening and closing
- from the inside 38
- from the outside 34

- Opening the rear window 40
- Outside temperature display 76
- Owner service procedure 141

## P

- Paint blemishes 142
- Paintwork
- minor repairs 143
- waxing 143
- Paint, care 142
- Park Distance Control (PDC) 78
- Parking brake 63
- Parking help 78
- Parking lamps 88
- Parking, winter 122
- Partition net 107
- PDC (Park Distance Control) 78
- Performance 184
- Phone, mobile 123
- Pocket lamp 101
- Pollen 93, 100
- Power outlet 105
- Power steering 123
- Power windows 43
- safety switch 44
- Pressure monitoring, tires 85, 178
- Pressure, tires 28, 124

## Q

- Quality Grades 125

## R

- Radiator 187
- Radio
- refer to the separate Owner's Manual
- Radio Data System (RDS) 174
- Radio reception 123, 174
- Rain sensor 69, 177
- RDC (Tire Pressure Control) 85, 178
- RDS (Radio Data System) 174
- Reading lamps 88
- Rear backrest, folded down 108
- Rear hatch lamp
- bulb replacement 157
- Rear lamps 156
- Rear seat backrest, folding 107
- Rear window
- defroster 70, 92, 99
- Rearview mirror 51
- Recirculated air control 92
- automatic 99
- Recirculated-air mode 92
- Reclining seat 46
- Refueling 27

# Everything from A to Z

Remote control [35](#)  
Removal from service of the vehicle [147](#)  
Removing condensation from the windows [94](#)  
Reporting safety defects [7](#)  
Restraint system [54](#)  
Retaining straps [40](#)  
Reverse [17](#), [64](#)  
Roll-up cover [107](#)  
Roof load capacity [186](#)  
Roof luggage rack [111](#)  
Rubber parts [121](#)

## S

Safety belt height adjustment [53](#)  
Safety belt tensioners [175](#)  
Safety belts [53](#)  
    height adjustment [53](#)  
Safety defects, reporting [7](#)  
Safety feature [43](#)  
Safety lock buttons [38](#)  
Seat  
    electric power [48](#)  
    mechanical [46](#)  
Seat adjustment [46](#)  
Seat heating [100](#)  
Seat memory [49](#)  
Securing cargo [110](#)  
Securing loads [110](#)

Selector lever, automatic transmission [65](#)  
Self-defrosting mirrors [51](#)  
Self-diagnostics [179](#)  
Service and Warranty Information Booklet (US models) [140](#)  
Service Interval Display [74](#)  
Setting the temperature [98](#)  
Shiftlock [65](#)  
Side airbags [58](#)  
Side impact Head Protection System [58](#)  
Side lamps [87](#)  
    bulb replacement [154](#)  
Ski bag [106](#)  
Skid control [122](#)  
Sliding/tilt sunroof [44](#)  
    close in the event of an electrical short [166](#)  
    convenience operation [34](#)  
Slippery roads [122](#)  
Snow chains [121](#)  
Socket [104](#)  
    for electrical appliances [104](#)  
    for flashlights [104](#)  
    for vacuum cleaner [104](#)  
    refer also to power outlet [105](#)  
Space-saver spare tire [159](#)

Spare key [32](#), [35](#)  
    with radio remote control [32](#), [35](#)  
Spare tire [159](#)  
Spark plugs [188](#)  
Speaker [103](#)  
Speed control [71](#)  
Speedometer [18](#)  
Sports seat [48](#)  
Sports steering wheel [25](#)  
Starting assistance [167](#)  
Starting  
    problems [115](#), [167](#)  
Starting the engine [61](#)  
Steel wheels [129](#)  
Steering [123](#)  
Steering wheel lock [61](#)  
Steering wheel,  
    adjusting [50](#)  
Steptronic [65](#)  
Stereo system – harman kardon [101](#)  
Stopping the vehicle [62](#)  
Storage compartments [102](#)  
Storing the vehicle [147](#)  
Stroke [184](#)  
Summer tires [127](#)  
Sun visors [51](#)  
Sunroof [44](#)  
Switching off the engine [62](#)  
Symbols [4](#), [163](#)

Synthetic oils [136](#)

## T

Tachometer [73](#)  
Tail lamps [156](#)  
    bulb replacement [156](#)  
Tailgate  
    emergency release [166](#)  
Tailgate lamp, bulb replacement [157](#)  
Tank capacity [187](#)  
Technical data [184](#)  
Technical modifications [6](#), [148](#)  
Telephone  
    refer to the separate Owner's Manual  
Telephone hookup [103](#)  
Temperature adjustment [98](#)  
Temperature display,  
    outside temperature [76](#)  
Temperature gauge, engine coolant [74](#)  
Temperature layering [93](#), [100](#)  
Thigh support area,  
    adjusting [48](#)  
Third brake lamp [157](#)  
Tilt alarm [42](#)  
Tilt sensor alarm system [36](#)  
    remote control [36](#)  
Tire changing [159](#)

Tire codes [127](#)  
Tire damages [124](#)  
Tire inflation  
  pressure [28](#), [124](#)  
Tire Pressure Control  
  (RDC) [85](#), [178](#)  
Tire pressure  
  monitoring [85](#), [178](#)  
Tire Quality Grading [125](#)  
Tire replacement [125](#), [126](#)  
Tire specifications [129](#)  
Tire tread [124](#)  
Tools [152](#)  
Torque [184](#)  
Tow fittings [168](#)  
Tow starting [168](#)  
Towing [168](#)  
Track [185](#)  
Traction Control System,  
  refer to DSC [79](#)  
Transmission [64](#)  
Transporting children  
  safely [58](#)  
Tread depth, tires [124](#)  
Trip odometer [73](#)  
Trunk [38](#)  
Turn signal  
  indicator [23](#), [68](#), [154](#)  
  bulb replacement [154](#)  
Turning radius [185](#)  
Two-way radios [123](#)

## U

Uniform Tire Quality  
  Grading [125](#)  
Used batteries [164](#)

## V

Vacuum cleaner,  
  connecting [104](#)  
Vanity mirror [51](#)  
  bulb replacement [158](#)  
Vehicle battery [162](#), [188](#)  
Vehicle care  
  exterior [142](#)  
  interior [144](#)  
Vehicle Identification  
  Number (VIN) [139](#)  
Vehicle immobilizer [33](#)  
Vehicle painting [142](#)  
Vehicle removal from  
  service [147](#)  
Vehicle storage [147](#)  
Vehicle weight [186](#)  
Ventilation [90](#), [93](#), [96](#)  
  draft-free [93](#), [100](#)  
Vinyl upholstery, care [144](#)  
Voice recognition [24](#), [25](#)

## W

Warning lamps [20](#)  
Warning messages [75](#)  
Warranty and Service Guide  
  (Canadian models) [140](#)

Washer fluids [134](#)  
Washer nozzles [134](#)  
Washer reservoir, filling [134](#)  
Washing your car [141](#)  
Water on roadways  
  deep water [115](#)  
Waxing, paintwork [143](#)  
Weights [186](#)  
Wheel changing [159](#)  
Wheel lug wrench [159](#)  
Wheel rims [127](#)  
Wheel stud wrench [159](#)  
Wheelbase [185](#)  
Wheels and tires [127](#), [129](#)  
Width [185](#)  
Windows, convenience  
  operation [34](#)  
Windshield washer nozzle  
  adjustment [134](#)  
Windshield washer reservoir,  
  filling [134](#), [187](#)  
Windshield wiper [68](#)  
  blade replacement [152](#)  
Winter operation [121](#)  
Winter tires [127](#), [128](#)  
Wiper blade  
  replacement [152](#)  
Wiper system [68](#)  
Work in the engine  
  compartment [130](#)

## X

Xenon lamp [154](#), [180](#)

# Owner service procedures

## A

- Activated-charcoal filter,  
changing 165
- Adding brake fluid 138
- Adding engine coolant 138
- Adding engine oil 135
- Adjust washer nozzles 134
- Air pressure, checking 28
- Antifreeze 138

## B

- Backup lamps  
bulb replacement 156
- Battery  
care 163  
charging 164  
removal and  
installation 163
- Brake fluid, adding 138
- Brake lamps  
bulb replacement 156
- Brakes, brake faults 120

## C

- Changing a tire 159
- Changing a wheel 159
- Changing the  
microfilter 165
- Charging the battery 164

- Check air pressure 28
- Check Control 75
- Checking air pressure 28
- Checking engine oil  
level 135

## D

- Defrost setting 94
- Defrosting the windows 94
- Difficult steering 123
- Disposal  
batteries 164  
engine oil 136
- Doors, emergency  
actuation 34

## E

- Electrical accessories,  
failure 164
- Electrical defect  
fuel filler door 166  
sliding/tilt sunroof 166
- Emergency operation  
doors 34  
fuel filler door 166  
luggage  
compartment 166  
sliding/tilt sunroof 166

## Engine oil

- add 135
- quality 136
- specifications 136
- viscosity 136
- Engine oil level,  
checking 135

## F

- Failure messages 75
- Filling washer reservoir 134
- First-aid kit 26
- Fittings, tow starting and  
towing 168
- Flat tire 159
- Footwell lamps, bulb  
replacement 158
- Front fog lamps  
bulb replacement 155
- Fuses, replacing 164

## G

- Glove compartment lamp,  
bulb replacement 158

## H

- Hatch lamps  
bulb replacement 156
- Hatch, emergency lock  
operation 166
- Hazard warning flashers 26
- Hazard warning triangle 26
- Headlamp cover, care 153
- High beams, bulb  
replacement 153

## I

- Indicator lamps 20
- Inflated pressure 28
- Interior lamps, bulb  
replacement 158
- Interior motion sensor,  
switching off 42

## J

- Jack 159

## L

- License plate lamp  
bulb replacement 157
- Low beams, bulb  
replacement 153
- Lug wrench 159

Luggage compartment  
emergency actuation 166

Luggage compartment  
lamps, bulb  
replacement 158

## M

Maintenance 140

Malfunction displays 75

Microfilter, change 165

Motion sensor, switching  
off 42

## O

Oil  
quality 136  
specifications 136  
viscosity 136

Onboard tool kit 152

## P

Pressure, tires 28

## R

Rear hatch lamp  
bulb replacement 157

Rear lamp 156

Release the hood 130

Releasing the fuel filler door  
after an electrical  
defect 166

Removing condensation  
from the windows 94

Replace windshield wiper  
blades 152

Replacement key 32

Replacing lamp bulbs 153

Replenish washer  
reservoir 134

Return used batteries 164

## S

Side lamps  
bulb replacement 154

Sliding/tilt sunroof  
close in event of electrical  
defect 166

Space-saver spare tire 159

Spare key 32

Spare tire 159

Spare wheel 159

Starting problems 115

Switching off tilt alarm/  
interior motion sensor 42

## T

Tail lamps  
bulb replacement 156

Tailgate lamps  
bulb replacement 156

Tailgate, emergency lock  
operation 166

Tilt alarm, switching off 42

Tire changing 159

Tire damage 124

Tools 152

Tow fittings 168

Tow starting 168

Towing 168

Turn signals, bulb  
replacement 154

## U

Use antifreeze for  
radiator 138

Used batteries 164

Used engine oil 136

## V

Vanity mirror lamp, bulb  
replacement 158

## W

Warning lamps 20

Warning messages 75

Washer fluid, adding 134

Washer nozzles,  
adjusting 134

Washer reservoir, filling 134

Wheel changing 159

Windshield wiper blades,  
replacing 152

Working in the engine  
compartment 130





# Refueling



So that you will have important specifications available when you stop to refuel, we recommend that you supplement this table with data which apply to your vehicle.

## Fuel

Designation	Premium Unleaded Gasoline
AKI: minimum	91

## Engine oil

Quality	
---------	--

The oil volume between the two marks on the oil dipstick corresponds to approx. 1.1 US quarts (1 liter).

## Tire inflation pressures

	Summer		Winter	
	Front	Rear	Front	Rear
4 persons				
5 persons or 4 plus luggage				

3 sport wagon US-En

**We wish you an enjoyable  
driving experience.**



**The Ultimate Driving Machine**